



D 250 AHG
D 250 AHGA

OPERATOR'S
MANUAL

ENGLISH
ORIGINAL MANUAL





D 250 AHG **D 250 AHGA**

ORIGINAL MANUAL



Foreword

■ Thank you for choosing this AUSA Model dumper. The purpose of this Operators Manual is to provide you, the user, with instructions concerning the productive, safe and efficient use of this dumper. Remember that "you" are the key to maintaining these characteristics. Correct use of the dumper will enable you to take full advantage of the features it has to offer.

You should read and understand this Manual before operating the dumper. Its purpose is to provide instructions for those persons in contact with the new dumper, and especially for the vehicle owner/operator. Its content will help you to understand the AUSA dumper better, and learn all you need to know about operations instructions, dumper controls, starting the dumper, driving technique, care and maintenance, designed uses of the dumper and the safety instructions that need to be followed.

AUSA cannot be held responsible for any damages caused by improper use of the dumper.

Please contact your official AUSA agent or dealer if you have any queries, complaints or orders for spare parts.

For further information you may write, FAX or E-mail to:

AUSA Center, S. L. U

Apartado P.O.B. 194

08243 MANRESA (Barcelona), ESPAÑA

Tel. 34-938 747 552 / 938 747 311

Fax 34-938 736 139 / 938 741 211 / 938 741 255

E-mail: ausa@ausa.com

Web: <http://www.ausa.com>

AUSA is continually improving its products, and reserves the right to make such improvements without incurring any obligation to make changes to dumpers previously sold. Because of this policy, claims cannot be made based on the data, illustrations and descriptions found in this manual.

Use only original AUSA spare parts. Only thus can you guarantee that the dumper will continue to give the same level of technical performance as when purchased. No modifications must be made to the dumper without prior authorisation from the manufacturer.

Keep this manual in the document carrier, located underneath the engine right panel (**fig. 1**).



(fig. 1)



Index

Predicted uses with the dumpers	5
Special safety messages	6
Plates and decals	11
Specifications	12
How to identify the Dumper.....	16
Controls/Instruments/Equipments.....	17
Operating the dumper.....	24
Break-in period	27
Before starting the dumper	28
Transporting the dumper	29
Fluids and lubricants	32
Special procedures	35
Periodic maintenance operations.....	37
Maintenance chart.....	55
Greasing points	57
Electric diagram	58
Hydraulic diagrams	64
EC Declaration of conformity AHG	67
EC Declaration of conformity AHGA	68

D 250 AHG / D 250 AHGA



Predicted uses with the dumpers

The dumpers have been designed and developed to transport material in bulk, (such as mortar, concrete, arena, sand and garbage or rubble).

Any other use has not been predicted so will be considered as improper.

The strict respect of operation maintenance and repairing conditions specified by the manufacturer are essential for a correct use.

Driving, maintenance and repairing must be done exclusively for trained people with proper tools and with good knowledge about the dumper.

All transport, maintenance or repairing operations, must respect safety and hygienic regulations at work and contingency plans. In public roads must follow current laws (Highway Code).

AUSA is not responsible for any damage occurred as a results of any modification in the dumper without authorisation.

■ Improper use

Improper use is understood as the use of the dumper in a way that does not conform to the criteria and instructions of this manual and in a way that may cause harm to people or damage to property.

The following are some of the most frequent and dangerous instances of improper use:

- Transporting people in the hopper.
- Failing to comply scrupulously with the instructions for use and maintenance set out in this manual.
- Overloading.
- Working on unstable, unconsolidated ground, or on the edge of ditches and trenches.
- Using accessories and equipment for purposes other than those they are designed for.
- Using accessories and equipment other than those manufactured or authorised by AUSA.

6



D 250 AHG / D 250 AHGA



Special safety messages

■ AUSA develops their dumpers according to the requirements of self protection, by current laws in European Economic Community, if the machine is used and maintained as required in this manual. Any harm occurred as results of improper use will be imputed to the user, and not to AUSA.

This part shows instructions about how to use the dumper, according to Machine Safety Guideline 98/37/CEE.

■ As an operator, think about...

- Do not operate this dumper unless you have read and understand the safety and operational contained in this Operators Manual and have been instructed and trained in the safe operation of this dumper (**fig. 1**).
- Wear protective clothing which is suitable and will protect you in the working environment. This may include a helmet, ear plus, protective goggles, reflective clothing or safeties glasses (**fig. 2**).
- Do not wear loose clothing or jewelry or long air as these could become entangled in the controls, in moving parts or edges of the machine and prove dangerous.

■ Depending on work environment...

- If in work environment exists any danger of fire or explosion, because of the goods stored or any gas or fluid potential escapes, check it the dumper flameproof protection is safe enough.
- If working in an enclosed area make certain there is sufficient ventilation to prevent excessive build-up of exhaust fumes. Under these conditions always stop the engine when not in use.
- In public roads, the dumper has to be equipped with all the permit and the authorisations by the current laws. And the driving license for the user will be required.
- Current legislation doesn't force to use roof structure to protect against falling objects. But if the use of the dumper is in this type of situation, the law specifics this kind of structure.
- The use of the dumper without lights, is allowed just in daylights or in well illuminated environments.

■ Before starting the dumper (**fig. 3**)

- Before starting the dumper, clean any oil or fuel leaks that may exist on the dumper controls or operating area and test the following items:
 - Check tire conditions and pressure.
 - Check brake functioning.
 - Check for any leaks in the fuel, hydraulic or cooling systems, etc.
 - Correct position and well fixed of any protectors, tops and security elements.
 - Absence of fissures or other structural visible problems.
 - Check that all controls are working correctly.
 - Check the following fluid levels:
 - fuel.
 - braking fluid.
 - Oil hydraulic circuit.
 - cooling system fluid.
- Check the operator seat's safety belt and its attachments. Inspect carefully the condition of this device with special attention to:
 - cuts or gossips in the tape.
 - wear or damages in the ironworks including the points of anchorage.
 - badly functioning of the clasp of closing or of the winder.
 - seams or free points of sewing.
- Check the position of all the tops, protections and other security elements of the dumper.

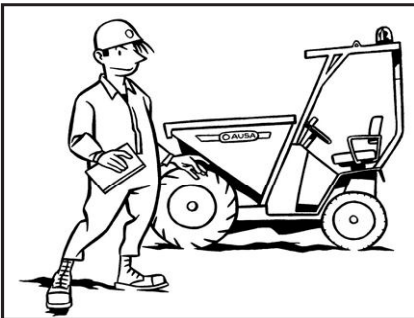

(fig. 1)

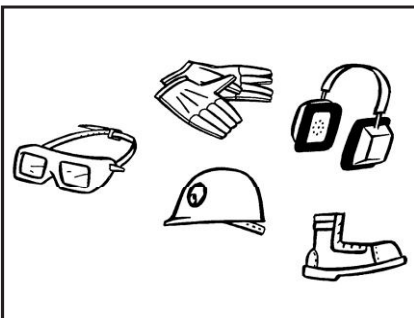

(fig. 2)

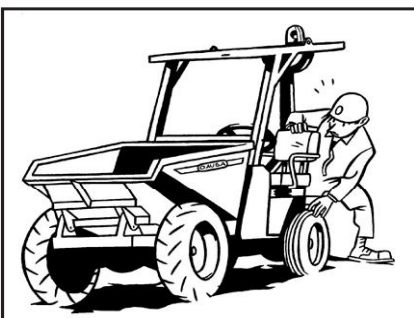

(fig. 3)

D 250 AHG / D 250 AHGA



Special safety messages



(fig. 1)

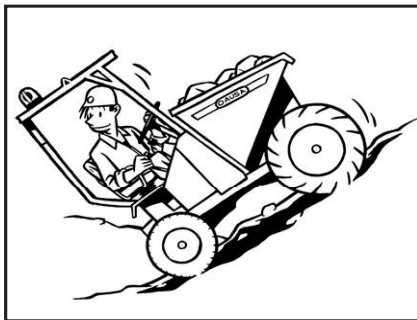

(fig. 2)



(fig. 3)



(fig. 4)

- Check if the mechanism alarm and signing (for example: acoustic warnings, indicator of clogging of the filter of air admission, etc.) working properly.
- Clean and check all informative and safety plates of the dumper.
- Clean and check signaling and lighting systems.
- Check battery connections and electrolyte level.
- Check seat position according users measures.
- Never start or operate any of the controls unless seated in the driver's seat.
- For safety reasons, don't forget to fasten the seat belt correctly, and its attachments.
- Keep driving room clean and free of any kind of objects to prevent obstructions with pedals or commands **(fig. 1)**.
- Although is not recommended, if an ether spray is used to start the engine in low temperatures, it has to be done with sufficient ventilation, and without any fire around.
- Keep those sprays in safe place, for away from heat or fire.
- Always stop the engine and do not smoke when carry out the fuel filling the dumper. Don't mix alcohol with fuel.

■ At work with the dumper, don't forget... (fig. 2, 3, 4)

- If you see any malfunction or disorder when using the dumper, notice it to your superior or maintenance services.
- Keep your hands and feet within the area designated for the driver.
- Put much attention to the slope work. Move very carefully and slowly. Never position the dumper sideways on a slope and don't work on slopes higher than recommended. The surmountable slope, does not mean that in the same one it can be manoeuvred with absolute security in any condition of load, land or manoeuvre. This means reversing backwards down a slope to maintain maximum load stability **(fig. 2)**.
- In any case, is not recommended to operate on slopes higher than 20% in wet lands or 30% in dry lands.
- Never come down a slope in neutral gear.
- Give way to the right at the pedestrians.
- This dumper was designed to carry loads not people. Do not transport people in the bucket. Do not let people ride on any other part of the dumper **(fig. 3)**.
- Do not overload the dumper. Make the manoeuvre with smoothness, in special the changes of direction in sliding land.
- Be certain you have good visibility at all times. If the load does not allow forward vision, then drive slowly with caution in reverse **(fig. 4)**.
- When one approaches a crossing without visibility, reduces the speed, it slowly signals acoustic and advance in agreement with the visibility which it has.
- Dumper's speed must be appropriate to work conditions and environment. Going continuously at top speed can be dangerous for the user and environment.
- Make certain that the ground on which you are driving will safety support the dumper and its load. Be very careful when approaching the edge of an embankment, wrought or temporary bridges on a construction site. **(fig. 1)**
- Before shifting the directional control lever into reverse, make certain that the way is suitable for safe dumper travel and that there are no people or objects behind the dumper. **(fig. 2)**
- Always drive the dumper with the bucket at its normal level travel position.
- Don't make two movements of the hopper simultaneously.
- Stay alert. Concentrate fully on your work. Your safety and that of others depends on the care you take when operating this dumper. **(fig. 3)**
- When circulating around the public routes with dumper circularly with the adjustable hopper to 180°, the longitudinal axis of the same one must be oriented in the direction of movement.
- Depending on the land, try to not raise a lot of dust.



Special safety messages

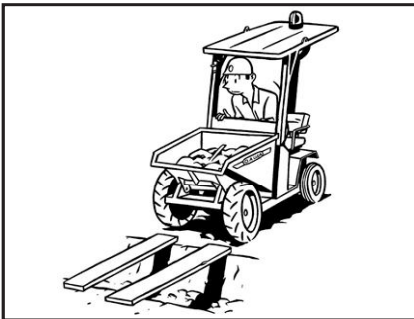

(fig. 1)

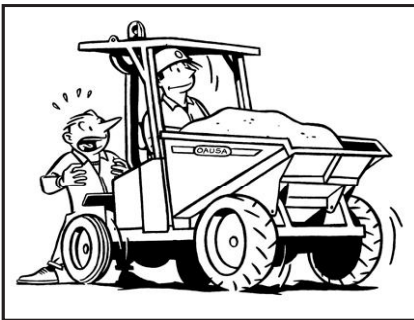

(fig. 2)

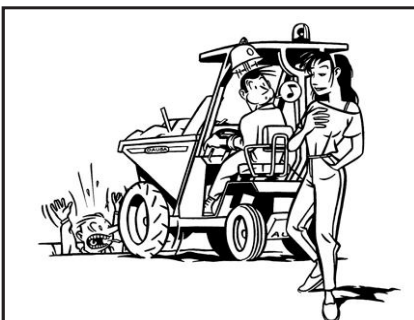

(fig. 3)



(fig. 4)

- Dumper is not a designed machine to tow others dumpers. If in case of necessity, places certain load in the hopper to assure the traction.
- Drive with safety and slow speed; and if the tow hasn't inertia brake, make sure dumper's brakes are strong enough for the two components.
- If dumper it both has the optional possibility of traction to axes, thinks that this one solely must be connected when it is necessary to save a obstacle, slope or sliding surface, and run at reduced speed to preserve the wearing down of the tires and not to put under the joint traction-direction of excessive efforts.

■ Be careful when loading and unloading the dumper...

- Don't put the load near a slope without consolidating and without a railing of top of security for the wheels to a sufficient distance of the edge exists. A plank of edge of 8 cm., cannot consider a top acceptable. **(fig. 4)**
- When tipping the bucket forward to unload, the centre of gravity of the dumper changes constantly and both the condition of the ground and the skill and experience and good judgement of the operator are essential to the stability of the dumper.
- When the bucket is being filled by some mechanical means, such as a crane or a mechanical loader, the driver should get off the dumper to avoid being hit by flying pieces of the load. **(fig. 1, next page).**
- Do this unloading maneuver gradually to keep dumper's stability. Avoid to transport materials that adhere dangerously to the same one (for example: clayey mud) or that is joined in the same one (for example: stone blocks), since the uncontrol that can take place in the spill manoeuvre, puts in danger the stability of dumper.

■ When leaving the dumper...

- Stop the engine and cut the ignition circuit. Level the bucket in its transit resting position. **(fig. 2-next page).**
- Set all the controls in the neutral position (rest).
- Apply the parking brake.
- Lock all mechanisms to prevent any unauthorised person from using the machine. Remove the ignition key. If it must leave dumper in a slope, besides to drive the parking brake, immobilise the wheels with suitable wedges.
- Leave parked dumper in the anticipated areas to the effect, without holding up routes of step, exits or accesses to stairs and emergency equipment.
- Dumper of articulated chassis, when leaving it, leaves it always on guard straight.

A good conservation is security guarantee for that reason...

- Dumper efficiency and safety of operation requires proper and regular maintenance. Only qualified mechanics with proper tools should perform maintenance operations and make any necessary repairs to the machine.
- Unless work on the engine demands that it be running, all repairs and maintenance on the machine should be done with the machine parked, engine stopped, unloaded, and wheels blocked to keep the dumper from moving during servicing.
- Some operations one more affordable with hopper raised, in unloading position. First of all must be locked against involuntary turning over, with the specified mechanisms in each model of dumper. **(fig. 3)**
- Take precautions to avoid spilling before disconnecting any of the fluid system circuits. Never use an open flame to check fluid leaks or levels.
- The hydraulic system should be checked periodically to avoid poor performance or accidents which might be caused by hydraulic oil leaks or by misalignment of the pressure relief valves.



Special safety messages

- Also all the elements must be reviewed periodically whose wearing down or aging can suppose a risk, for example: hydraulic pipes, trimmings of brakes, band of tread of the tires, etc.
- To be a security element, in case that the roof or arc of protection of the operator has undergone some blow that has produced it a permanent set, it must be replaced by a new piece.
- Number plates, instructions and warnings on dumper must stay in perfect state of reading.
- Any modification that affects to the capacity and security of dumper must be authorised by the manufacturer or a responsible industrialist, modifying, as soon as it is necessary, the plates and books of instructions.
- The manufacturer does not assume any responsibility in relation to incidences or accidents derived from the use of non-original repair or spare parts conducted in factories non-authorized.
- When replacing tyres, the new ones must be as recommended in manual. For security reasons divided wheels do not have to be used (formed by two screwed rims).
- Manipulating or inspecting the dumper must be by predicted points for this machine, as appeared in this manual and with enough capacity devices. Because of the articulated chassis, first of all the two frames must be joined with specified strut.
- If must tow dumper, you use a towed bar preferably , or if you haven't the same one, a cable of sufficient resistance. In each cases, lock it in the appropriate areas, and do it at 10Km/h max. speed. If driving the towed dumper, take care at your hands position on the steering wheel, to prevent damage when turning.
- Check if the towing dumper has capacity sufficient of drag and braking to conduct this operation.
- If dumper it must be transported on the platform of a truck:
Do not transport the dumper with a full diesel fuel tank. Minimum diesel fuel tank.
- Apply the parking brake.
- Put blocks at the front and rear of the dumper tires y fix it to the platform.
- Firmly attach the dumper to the trailer or truck bed with chains, cable or tie-down straps to prevent any movement.
- In any intervention, make sure battery terminals are protected, so is not possible any contact between them and some tool, object, etc.
- Because chassis is articulated (direction by joint of frames), put the connecting link between the housings, so the articulation is locked. **(fig. 1)**
- Before any resistance welding job to the dumper, disassemble every electric and electronic parts, to prevent damages.
- If the towed dumper is hydrostatic operated, first of all, follow the instructions from this manual to unplug the operation of the motive axis, to make easily the unloading prevent risks for the hydrostatic group.
- When replacing a tire, make sure of which it mounts with the drawing of cover in the correct sense.

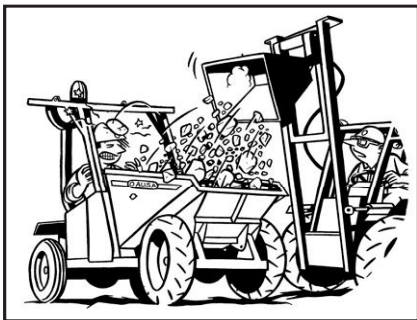

(fig. 1)

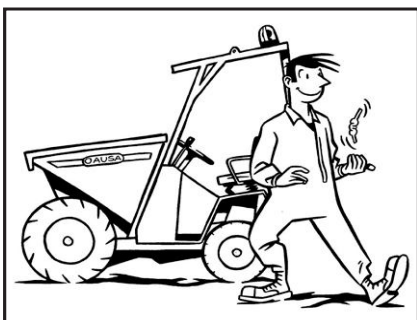

(fig. 2)

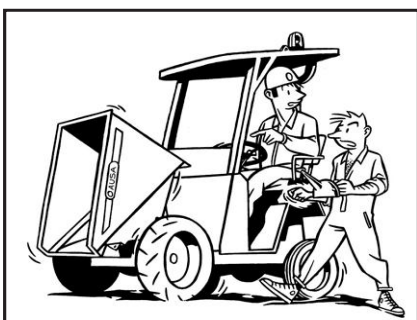

(fig. 3)

10



D 250 AHG / D 250 AHGA



Special safety messages

- Before working on refrigerating circuit, make sure the oil temperature is cold enough to open the radiator cap without risks.
- When you carry out the fuel filling and other fluids, use gloves to prevent cutaneous allergies and other dangers.
- Be respectful with the environment. When carrying out oil changes, fluids, tires, batteries, etc., take the old materials to the centres of recycled that correspond. When handling or scrapping silencers containing mineral fiber-based absorbing material, protect your skin with gloves and appropriate clothing. Dispose the waste products in dumps which have been specifically approved for this kind of materials. Also, at the end of the vehicle's life span, deliver it to an official scrap centre.
- If concrete is spilled on the road, remove it before harden.

ELECTROMAGNETIC COMPATIBILITY

- When using the machine in special areas with very sensible artifacts at electromagnetic emissions, check if they can be affected.



(fig. 1)



D 250 AHG / D 250 AHGA



Plates and decals

AUSA	TIPO-TYPE-TYP	
MADE IN SPAIN	MOTOR-MOTEUR-ENGINE	
	kW	
	ANO-ANNEE-YEAR-JAHR	
BASTIDOR-CHASSIS-FRAME		
PESO - POIDS	VACIO-A VIDE- UNLOADED-LEER	kg
WEIGHT - GEWICHT	CARGADO-CHARGE-LOADED-BELASTET	kg
EJE DELANTERO	CARGA NOMINAL-CHARGE NOMINAL	kg
ESSIEU AVANT	NOMINAL LOAD-ZULASSIGE LAST	
FRONT AXLE		bar
VORNACHSE		
EJE POSTERIOR	CARGA NOMINAL-CHARGE NOMINAL	kg
ESSIEU ARRIERE	NOMINAL LOAD-ZULASSIGE LAST	
REAR AXLE		bar
HINTERACHSE		
CARGA REMOLCADA EN HORIZONTAL-CHARGE REMORQUÉE EN PALIER	LOAD TOWED ON THE LEVEL - ZULASSIGE ANHÄNGELAST	kg
AUTOMOVILES UTILITARIOS, S.A. TEL. (9) 3-874 73 11- FAX (9) 3-874 12 55 E-mail:ausa@duma.com-Web:htp://www.ausa.com P.O.BOX. 164-08243 MANRESA (ESPAÑA) 01.00775.26		

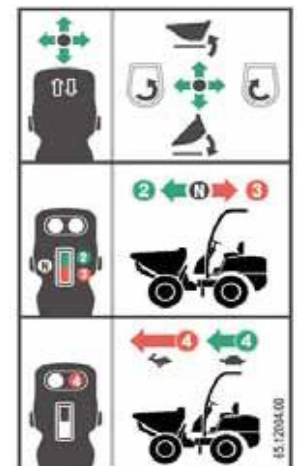
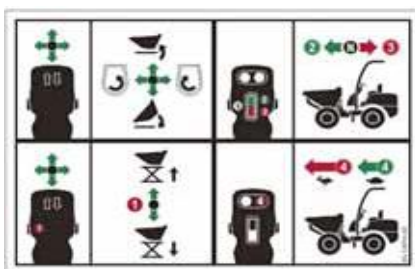
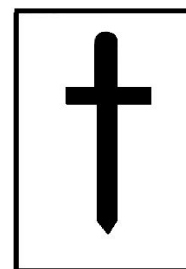
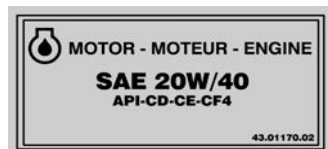
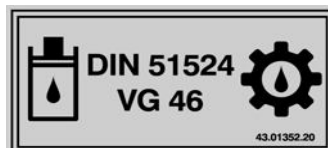

12



D 250 AHG / D 250 AHGA

Specifications

■ Diesel engine

D 250 AHG/AHGA:

Kubota V2403-M-E3B , water-cooled, four cylinders, four stroke with electrical starter.

Power:

Accordance with SAE J 1995 Standard: 36,5 Kw / 49,6 CV at 2600 rpm.

■ Transmission

Axles with planetary reduction at the wheel hub. Front axle with oil-bathed disc brakes.

Permanent X4 by transfer box.

D 250 AHG/AHGA:

Hydrostatic group with changeable flow pump and two-gear engine.

Working pressure: 420 bar.

Low gear: 6,1 km/h

High gear: 20 km/h

Reversing gear (forwards/backwards) is achieved by means of an electrical switch at the bottom of the joystick handle, placed in the seat's right-hand side.

When selecting the direction, corresponding arrow-shaped warning light flashes.

■ Steering

Hydraulic powered "ORBITROL", with acting hydraulic cylinder which controls chassis articulation

Work pressure: 110 bar.

■ Brakes

Service brake: watertight multiple discs in front axis, hydraulically operated.

Parking brake: watertight multiple discs in front axis, wire operated.

■ Wheels

Same model for the four wheels.

Wheels dimension: 10,0/75 - 15,3 (14 PR)

Front wheels pressure: 5 bar / (74 PSI). To see machine identification plate.

Rear wheels pressure: 4 bar / (57 PSI). To see machine identification plate.

■ Work temperature

From - 15°C to 40°C.

■ Hydraulic circuit

One gear pump steering system pump driven 12cc joined up to thermal engine.

Control valve for the dumper's operation:

D 250 AHG: monoblock 2 spool

D 250 AHGA: monoblock 2 spool and selectable solenoid

The relief valve of pressure is to: 175 bar.

Hydraulic tank capacity: 45 l.

D 250 AHG / D 250 AHGA



Specifications

■ Electrical equipment

- 2,0 Kw electric starter motor.
- Battery 12V and 70 Ah.
- Alternator 12 V / 480 W.
- Warm-up of diesel oil.
- Rotating beacon.
- Horn
- Acoustic warning rear speed.

■ Weight (with full tanks). To see machine identification plate.

D 250 AHG: 2.725 Kg.

D 250 AHGA: 2.995 Kg.

■ Maximum Load. See machine identification plate.

2.500 Kg.

■ Maximum weight. See machine identification plate.

D 250 AHG: 5.225 Kg.

D 250 AHGA: 5.495 Kg.

■ Maximum width.

D 250 AHG: 1.690 mm

D 250 AHGA: 1.877 mm

■ Overcome gradient

70%.

■ Controls panel

The controls are integrated in the front operator protector. The same way as the switches and the lamps of optional lighting equipment.

■ Protective arc ROPS

Built according to ISO 3471 regulation.

WARNING

The seat belt is an important part of this safety system and must always be fastened before operating the dumper. Failure to wear the seat belt in the event of an accidental tip over could result serious injury or death as you could be crushed by the dumper or by the overhead guard.



Specifications

■ **Minimal turning radius**

D 250 AHG: 4.225 mm.

D 250 AHGA: 4.330 mm.

■ **Bucket capacities**

	D 250 AHG	D 250 AHGA
Water	818 l.	817 l.
Level	1200 l.	1246 l.
Level Heaped	1910 l.	2063 l.

■ **Optional equipment**

- Lighting equipment.
- Narrow track (1.691 mm)



WARNING



Unloading operation always has to be done on flat, levelled and compact ground (see level indicator), even so, lateral unloading is always forbidden

- 1. Low lateral unloading (forbidden)**
- 2. High front unloading (allowed)**
- 3. High lateral unloading (forbidden)**



- Biologic Hydraulic oil



D 250 AHG / D 250 AHGA



Specifications

■ Measures machine
D 250 AHG model:

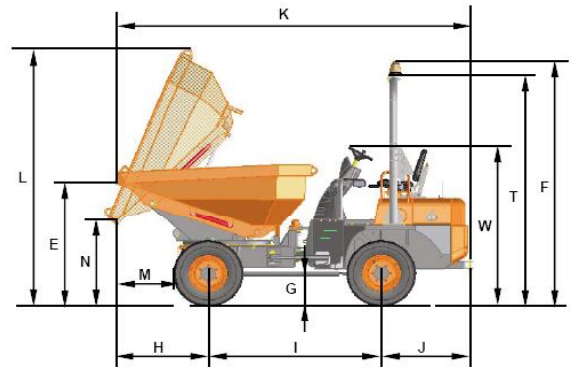
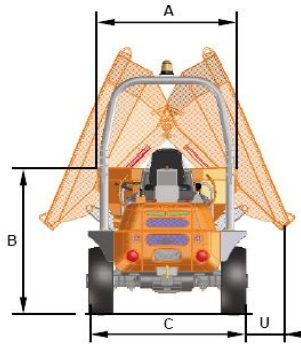

D 250 AHGA model:

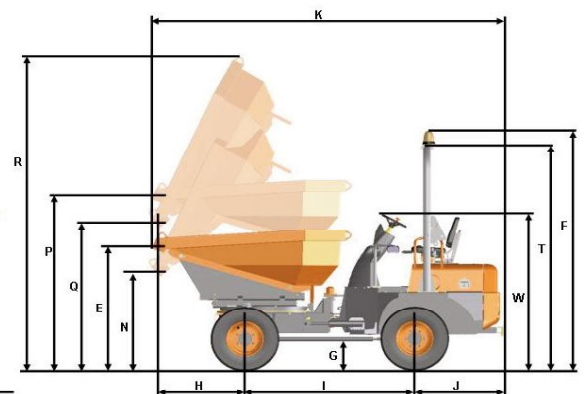
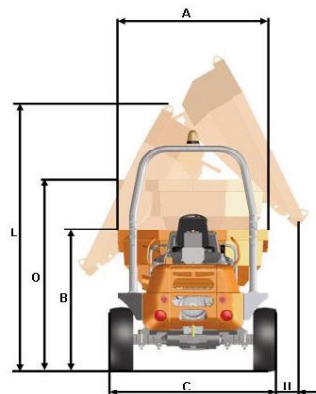

DIMENSIONS (mm)	D250AHG	D250AHGA
A	1503	1695
B	1694	1700
C	1775	1875
E	1500	1540
F	2915	2924
G	347	363
H	1050	980
I	1920	1920
J	1025	995
K	3975	4000
L	3070	3230
M	660	590
N	1050	1250
O	-	2300
P	-	2140
S	-	1850
R	-	3830
T	2705	2750
U	364	250
W	1909	1909



How to identify the Dumper



(fig. 1)



(fig. 2)

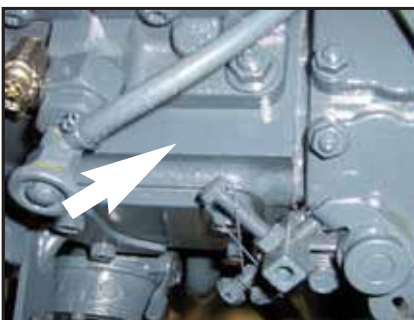

(fig. 3)



(fig. 4)

IMPORTANT!

Please indicate model number, date of purchase, frame and engine number when consulting your AUSA dealer for any matter. This information can be found on the identification plate. We recommend you make a record of these numbers in the spaces provided below for handy reference and keep it in your files.

Model dumper:

Date of purchase:

Chassis serial number:

Engine serial number:

- **The vehicle identification plate (fig. 1)** is placed in the front part of the engine protector (after the gear stick). Included the CE trademark.

- **The chassis serial number (fig. 2)** is marked in front crossbar in the right side of the chassis.

- **The engine serial number (fig. 3, 4)** it is marked in the block in the left side after the fuel filter and in an etiquette in the top part of the lid of balance beams.

- **Main components identification plates**

Identification plates for all the components not manufactured by AUSA, such as engines, pumps, etc. are affixed to the components themselves, in the positions where they were originally fitted by the respective manufacturers.

Controls Instruments Equipments

■ Term such as right, left front and rear when used in this Operators Manual indicate the right and left sides of the dumper, the front and the back of the dumper, as viewed from the operators seat looking forward.

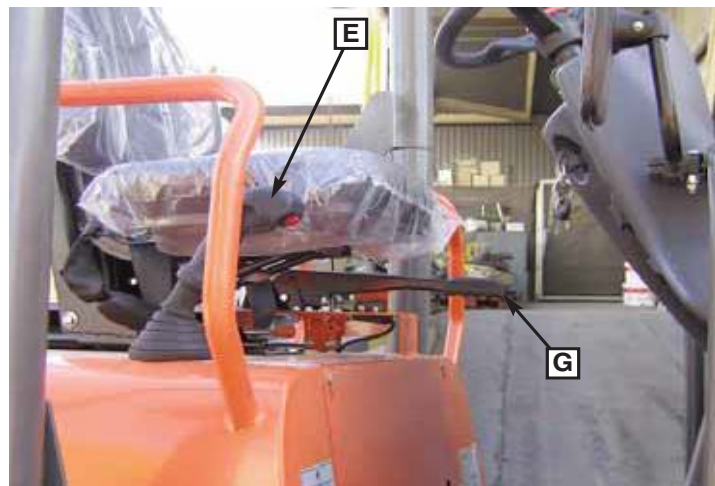

■ Identification components

- A- Protective arc.
- B- Driver seat with safety belt.
- C- Rotating beacon.
- D- Load hopper.
- E- Joystick.
- F- Steering wheel.
- G- Parking brake
- H- Lighting equipment (optional).



Controls Instruments Equipments

- **Pedals (fig. 1)**
A-Service brake pedal.
B-Accelerator pedal.

- **Acoustic warning rear speed.**
Its sounds when we select the reverse gear.

- **Joystick (fig. 2)**
The joystick, placed on the driver's right-hand side, controls the hopper power device, as well as the forward-backward gear control.

- **Direction control**
The direction control is effected by means of an electrical switch (C) on the joystick at the bottom side. When the lights of the arrows are off, the control switch is in neutral. Pushing the switch on the front side, the machine drives forward and pushing the switch on the rear side, the machine drives backwards. In each case the corresponding arrow will be lit, green (forward) and red (backward).

ATTENTION!

Not to effect sudden way changes, in order to avoid possible breaks in the transmission.

- **Speed control (fig. 3)**
Transmission fast/slow speed can be selected by pushing switch (d).

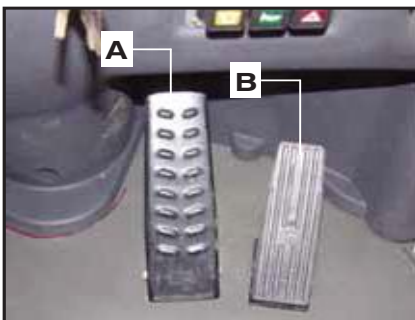

(fig. 1)



(fig. 2)



(fig. 3)

Controls Instruments Equipments

■ Parking brake (fig. 1)

Parking brake is activated by lever (A) and wire with blocking system located at the left side of the driver's seat.

Pull up the lever until blocking the wheels.

To release the handbrake pull down the lever by pushing the button fitted at the front side of the lever and fit it at rest position.

NOTE: The dumper is equipped with a device which disconnects the transmission with the hand brake on.

■ Emergency brake

In case of emergency, use parking brake.

■ Control for handling the skip (fig. 2, 3, 4, 5)

The skip is moved by using the joystick (b).

Loading / downloading the skip

Pushing joystick (b) forwards, tips the skip for unloading and pulling it backwards, moves the skip back down to its resting position.

Swinging the skip

The skip swings to the left or the right depending whether joystick (b) is moved towards the driver or pulled to the right.

REMARK:

Before swinging the skip, it must be raised enough to clear the locking device (b). When the skip is fully lowered, you should locate it into the (c).

Raising the skip (only AHGA model)

For raising the bucket, push button (d) located at the left side of joystick's handle (b) and push forward joystick (b) for raising the bucket and pull it backwards for lowering to its normal rest position.



(fig. 1)

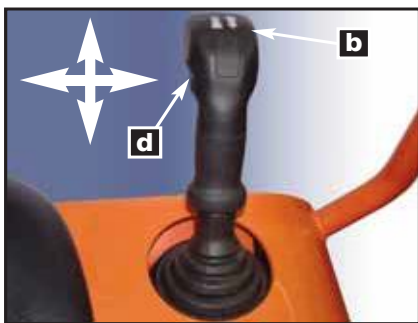

(fig. 2)

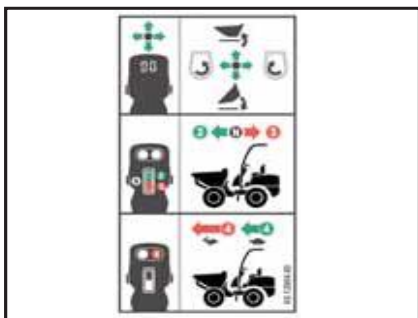

(fig. 3)

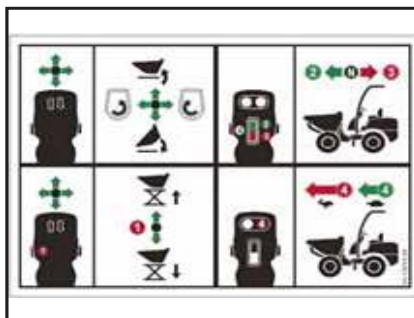

(fig. 4)

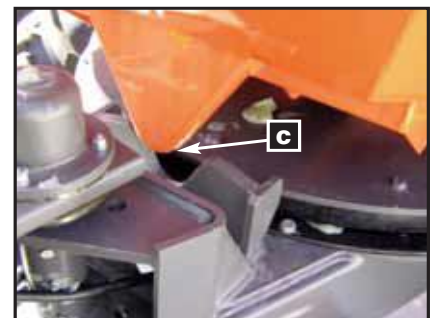

(fig. 5)

WARNING

Stay a safe distance from high tipping mechanism CRUSH zone in order to avoid operator's serious injuries.



**Controls
Instruments
Equipments**



WARNING



D250AHGA MODEL (Standard)

Unloading operation always has to be done on flat, levelled and compact ground (see level indicator), even so, lateral unloading is always forbidden

1. Low lateral unloading (allowed)
2. High front unloading (allowed)
3. High lateral unloading (allowed)



WARNING



NARROW AXLE (Optional) D250AHGA MODEL

Unloading operation always has to be done on flat, levelled and compact ground (see level indicator), even so, lateral unloading is always forbidden

1. Low lateral unloading (Forbidden)
2. High front unloading (allowed)
3. High lateral unloading (Forbidden)

Controls Instruments Equipments

■ Level indicator (only in model AHGA) (fig. 1, 2)

The level indicator (a) is placed in the centre pivot area, easily visible from the operator's seat. This indicator let the operator's know which the inclination of the front chassis is.

	WARNING	
<p>Operating with a loaded machine, in any case the bubble can overtake the 5° indicator's area. An inclination bigger than 5° do not assure the machine's stability.</p>		

	ATTENTION	
<p>Check the tires and adjust pressures frequently. See "PERIODIC MAINTENANCE OPERATIONS" in this manual. Operating with a low pressure can cause instability.</p>		

	ATTENTION	
<p>Check frequently on flan ground that the bubble remains in the indicator's centre. If not, please contact immediately with an AUSA dealer for its repair.</p>		

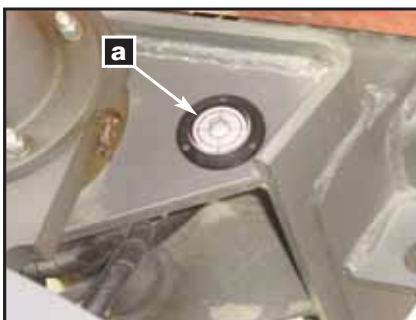

(fig. 1)



(fig. 2)



Controls Instruments Equipments

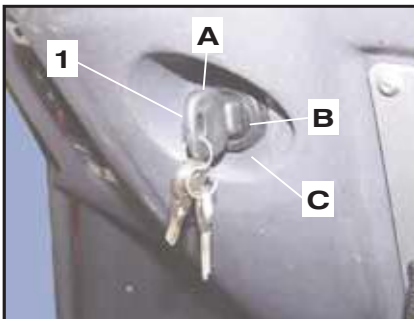

(fig. 1)

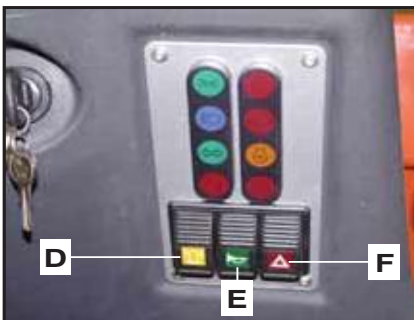

(fig. 2)

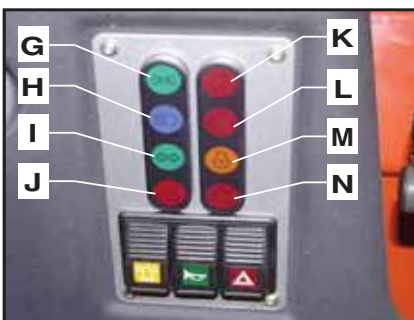

(fig. 3)

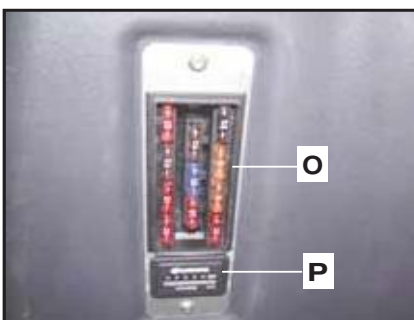

(fig. 4)

■ Control panel and controls

They are located in front protector and in joystick.

1- Starter switch, pre-heating and engine stop. (fig. 1)

It's located on the right side of the front protector.

(A) Stop (B) Pre-heating (C) Starter.

- Switches. (fig. 2).

D- Rotating beacon

E- Horn

F- Warning (only lighting version dumpers). They are located on the right side of the front protector. To switch on, push the button, it will light, to switch off push that button again.

- Lamps. They are located on the right side of the front protector. (fig. 3)

G- Position lights lamp (with lighting equipment). It is illuminated when we select this type of system of illumination.

H- High beam lamp (with lighting equipment). This lamp is lit when high beams are selected.

I- Turn signal lamp (with lighting equipment). This lamp will blink indicating turn signals are operating.

J- Engine temperature lamp. This gauge shows the condition of the coolant in the engine cooling system. When this lamp glows it means that the engine is operating at high temperature which could damage the engine. The engine should be stopped immediately to determine the cause of the high temperature. It might be due to a low level of cooling, dirt in the radiator or that the thermostat does not work correctly, break of the alternator belt or pump water.

K- Air filter lamp. When the air filter of the diesel engine becomes clogged with dirt, this lamp will light. The air filter should be immediately cleaned or serviced.

L- Oil pressure lamp. When this lamp is lit means that the engine oil level is low causing low oil pressure to the engine. The engine should be stopped immediately to prevent engine damage. Add oil to the engine until the proper level is reached.

M- Engine pre-heat lamp. When this lamp glows it indicates that the engine pre-heat plugs are in operation and heating the combustion chamber to a temperature that will enable firing of the vaporized diesel fuel.

N- Charge battery lamp. This gauge shows the condition of the battery and will tell you if the battery charge is too low or if the alternator is not charging properly. Once the engine starts to run, this red lamp will go out. If it remains lit, stop the engine and determine the cause.

O- Fuse box. (fig. 4). It's located on the left side of the frontal protector (O). The fuse box has places for 11 fuses. See the Electrical Diagram in this Manual to identify the number and function of each fuse.

P- Hourmeter. (fig. 4). It's located under the fuse box (P). The hourmeter records engine running time in hours. This enables servicing of the Vehicle at proper intervals. See MAINTENANCE CHART in this Manual.

D 250 AHG / D 250 AHGA



Controls Instruments Equipments

■ Multifunction switch (fig. 1, 2)

Located on the steering column.

Directional indicators. By pulling the lever (A) from its neutral point towards the driver, the left directional indicator is selected; and by pushing the lever to the front, the right directional indicators are selected. When the warning light (I) (see fig. 3 former page) flashes in the control panel and dashboard.

Sidelights / dipped headlights / full-beam headlights / flashes. Rotating the lever (A) to the first position the sidelights are connected. Turning it to the second position, the dipped headlights are connected. Pushing the lever downwards, the full-beam lights are connected. Pulling the lever upwards will select the flashing lights.

Horn. It is activated by pressing the end of the multifunction switch.

■ Using accessories and equipment

If the dumper is equipped with accessories, prior to using them, read carefully the Instruction Manual specific for the accessory provided by its manufacturer and enclosed in this main dumper Manual. If the accessories and equipment are to be mounted on the dumper basic chassis, by external suppliers (sub-suppliers), you must consider all the dumper prescriptions and limitations in regard to mass and dimension, effectiveness of the light system and its fitting, as well as the need of protections to additional systems so as to guarantee the dumper safety.



(fig. 1)



(fig. 2)



Operating the dumper

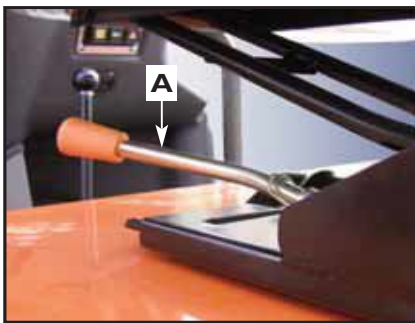

(fig. 1)



(fig. 2)



(fig. 3)

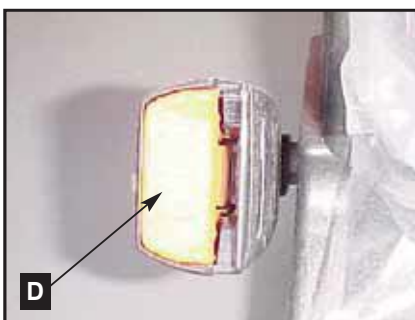

(fig. 4)

WARNING

Before each period of operation, check the dumper for correct operation of the steering, brakes, hydraulic controls, instruments and safety equipment and direction control. A machine that runs correctly is more efficient and can prevent accidents. Make all necessary adjustment or repairs before you operate the dumper.

■ Come in and come out of the dumper.

Don't hold and don't pull of the steering wheel to come in/off the dumper, use the handless located on the overhead guard and always support your foot on the rough bands of the step, to prevent any downfall when you come in or come out.

■ Adjust the seat (fig. 1, 2)

Before starting work with the dumper each day adjust the seat for the most comfortable position.

To move the seat backwards and forwards push the lever (A). Push the lever and move the seat to the desired position. According to the weight of the driver, set the seat with the lever (B). There are 24 turns of the lever from minimum driver weight of 60 kg. to maximum 120 kg.

Normally it is adjusted for a driver weighting 90 kg.

Ensure to fasten your seat belt.

■ Safety belt (fig. 3, 4, 5)

To fasten the belts, introduce the sideburn of hooking (C) in the clasp (D) until the "clac" of blockade is heard. To unbutton the belts, press the push-button (E). The seat belt must adapt to the body of the passenger who's using it, thus providing him/her with autonomy of movement, but adjusting the belt to the physical complexion of the driver.

■ Checking

With the starter engine and the stop dumper, carry out the following checks and tests: referred to BEFORE STARTING THE DUMPER in this Manual.

■ The rated capacity of the dumper (to see dumper identification plate)

The rated capacity of the dumper is the weight the dumper is capable of transport safe operating conditions, and this is determined by the weight limits of the load.

The use of attachments may be reduce the load capacity.

Poor ground conditions as well as shape of the load may affect safety conditions.

An overload on the hopper makes the dumper unstable, difficult to handle and will present the danger of tipping over or the breakage of some component.

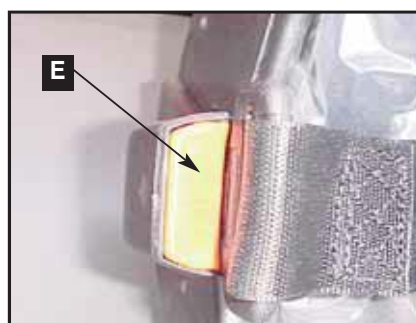

(fig. 5)

Operating the dumper

WARNING:

The vehicle handling, stability and braking distance are affected when loading racks and using the dumper. Correct loading and weight distribution are therefore important. Never overload, tow or carry cargo improperly. Always ensure the cargo is safely secured and properly distributed on the rack(s) before operating the vehicle. Safely reduce speed according to terrain conditions when carrying cargo or pulling a trailer. Allow greater distance for breaking. Always secure cargo as low as possible on the rack(s) to reduce the effect of a higher center of gravity. Failure to follow the recommendations here could cause changes in vehicle handling which could lead to an accident resulting in severe injuries including the possibility of death.

■ Cargo of the dumper

When cargoing vehicle, respect these maximum loads. See SPECIFICATIONS in this Operators Manual.

■ The relationship between the dumper and the load is altered by changes in:

- Use of attachments.
- Changes in the motion of the dumper and the grade of the ground on which it is moving.
- Smoothness and stability must be maintained while these factors change constantly during dumper operation.

This requires careful judgement on the part of the operator.

■ Starting and stopping the engine

Starter (fig. 1)

For safety reasons, when starting the engine the driver should be sitting on his seat with the seat safety belt fastened, the directional control switch in neutral position and the parking brake engaged.

Insert the key in the switchboard of take-off and turn it to the position (B) of contact until the witness of warm-up goes out, press the pedal of the accelerator 1/4 of his career and turn the key to the position (C) until the engine take-off. Do not support it in this position more than 15 seconds. If the engine fails to start, repeat all above steps. Allow 30 seconds between attempts.

NOTE: These dumper have start's lock. Keep in mind that:

To start the engine, electric switch must be in neutral position.

IMPORTANT!

With cold weather, have the engine running some minutes to improve oil circulation and lubrication.

Jump starting the machine

Starting the machine by means of a booster battery can be done by using other 12 volt batteries which may then be connected to the starter motor. If using another machine or dumper for this purpose make certain the two machines do not touch.

- 1- Apply the parking brake.
- 2- Open the engine cover of dumper.
- 3- Connect the positive (+) cable of the booster batteries to the positive (+) terminal of the dumper battery. Connect the negative (-) cable of the booster batteries to a good ground connection on the frame of the dumper.
- 4- Start the dumper engine in the normal fashion.
- 5- Disconnect the booster cables in the same order, first disconnect the booster cables from the positive (+) terminal of the dumper battery and then disconnect the booster cables from the negative (-) terminal of the dumper battery.

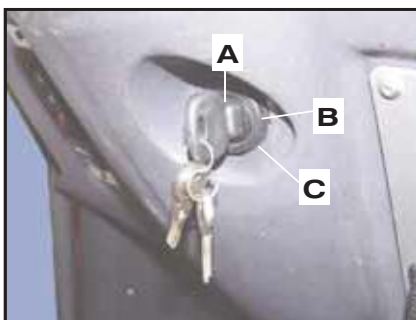

(fig. 1)



Operating the dumper

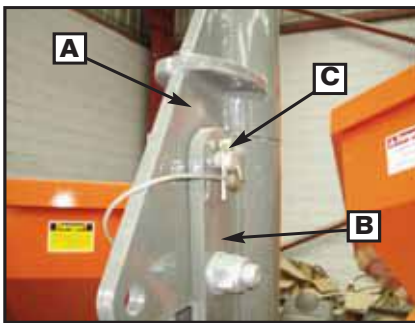

(fig. 1)

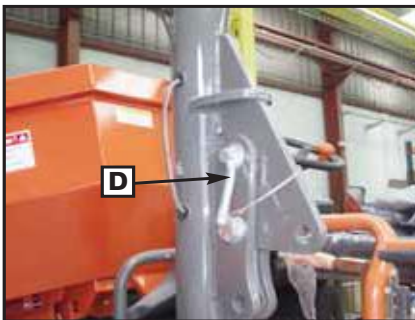

(fig. 2)



(fig. 3)



(fig. 4)

Parking the dumper and stopping the engine

Make certain that the forklift is parked on level ground when leaving it overnight. Also park it on level ground before any scheduled maintenance is attempted. Apply the parking brake. Keep the engine in idle for 1 minute if the dumper has been working at full load. Now turn off the key switch in a counterclockwise motion to stop the engine. Connect the stick of change or the directional control so that they facilitate an additional retention of the machine in case the stop brake was failing. It is strongly recommended to place blocks at the wheels. Remove the key from the ignition switch and take it with you. Never leave the key in a parked dumper.

Folding ROPS Frame Operating Procedure (fig. 1, 2, 3, 4)

The folding ROPS comprises of two sections (A & B) and is pivoted at head height allowing the ROPS to be tilted backwards thus reducing the transportation height of the machine, **but not the working height.**

Travelling position

	WARNING	
DO NOT DRIVE THE MACHINE WITH THE ROPS IN THE TRAVELLING POSITION		

This procedure is best carried out by reading the instructions below and following the diagrams at the bottom of this page.

1. Remove the two spring clips (C) from the locking pins (D) on both sides of the ROPS frame. **(fig. 1)**
2. Remove the locking pins (D). **(fig. 2)**
3. Carefully pull the top half of the ROPS frame (A) backwards lowering into the travelling position. **(fig. 3)**
4. Replace the locking pins (D) and fix in place using the spring clips (C). **(fig. 4)**

Working position

To turn the ROPS frame to its working position reverse the above procedure.

	WARNING	
Standing on the machine with your feet in the position shown will result in a loss of balance when lowering the ROPS frame and is not recommended.		

(fig. 5)



D 250 AHG / D 250 AHGA



Break-in period

■ Engine

A break-in period of 50 operating hours is required before running the dumper at sustained full throttle.

CAUTION:

This dumper has a 4-stroke engine. Oil must be added to engine base only.

During this period, maximum throttle should not exceed 3/4. However, brief full acceleration and speed variations contribute to a good break-in.

Continued wide open throttle accelerations, prolonged cruising speeds and engine overheating are detrimental during the break-in period.

■ 50-Hour Inspection

As with any precision piece of mechanical equipment, we suggest that after the first 50 hours or 30 days after the purchase, whichever comes first, your dumper be inspected by an authorized AUSA dealer. This inspection will give you the opportunity to discuss the unanswered questions you may have encountered during the first hours of operation.



Before starting the dumper



WARNING



These checkings are essential before putting in functioning the dumper.

Always check the proper operation of controls, safety systems and mechanical components before starting. If not done as specified here, severe injury or death might occur.

- Check tire pressure and condition.
- Check location of controls and ensure they work properly.
- Verify steering operates freely.
- Activate accelerator pedal and clutch pedal several times to ensure they operates freely.
It must return to idle position when released.
- Activate the brake pedal to make sure the brakes work properly. Pedal must fully return when released.
- Ensure directional control switch are working properly.
- Check fuel, oil, hydraulic oil and coolant levels.
- Check for oil leaks on the engine, hydraulic circuit and transmission components.
- Clean headlights and taillights (If they exist).
- Ensure engine protector is properly closed.
- Ensure seat belts are properly latched. Before initiating the day, inspect carefully the condition of this device with special attention to:
 - cuts or gossips in the tape.
 - wear or damages in the ironworks including the points of anchorage.
 - badly functioning of the clasp of closing.
 - seams or free points of sewing.
- If you transport cargo, respect load capacity. Ensure cargo is properly distributed.
- Look and feel for engine parts while engine is off. Check fasteners.
- Check operation of ignition switch, headlights, side lights, taillights indicator lights and acoustic warning of rear speed (If they exist).
- Start engine and drive forward slowly a few feet and activate the brake pedal to test them.

Correct any problem you may have found. See an authorized AUSA dealer as necessary.

D 250 AHG / D 250 AHGA



Transporting the dumper

■ Fixation / immobilisation of the dumper on a platform. (fig. 1, 2)

When transporting the dumper on a trailer or truck bed, carefully follow the instructions in the Caution Decal.

WARNING

Before you put the dumper on a trailer or truck bed, make certain that the ramp is strong enough to support the load and that the parking surface is free of debris, oil, grease or ice.

- **Do not transport the dumper with a full diesel fuel tank.**
- **Make certain your seat belt is properly fastened.**
- **Move the dumper slowly and carefully up the ramp onto the trailer.**
- **Apply the parking brake.**
- **Stop the engine and remove the key of ignition switch.**
- **Put blocks at the front and rear of the dumper tires.**
- **Firmly attach the dumper to the trailer or truck bed with chains, cable or tie-down straps to prevent any movement, using the points on the dumper designed for this purpose.**
- **FRONT AXIS: by the ears welded on the chassis (fig. 2)**
- **BACK AXIS: over the back wheels.**
- **Keep in mind that the fixation systems are adapted and sufficiently resistant for this purpose.**

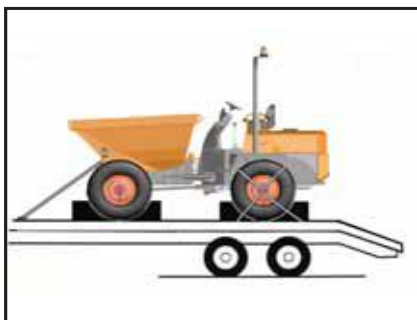

(fig. 1)



(fig. 2)

30



AUSA

D 250 AHG / D 250 AHGA

Transporting the dumper



(fig. 1)

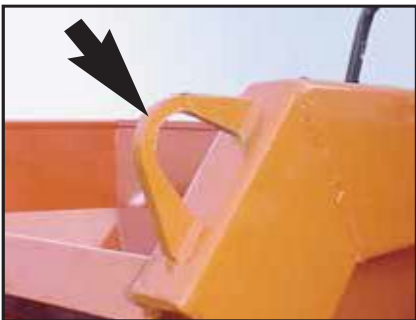

(fig. 2)



(fig. 3)

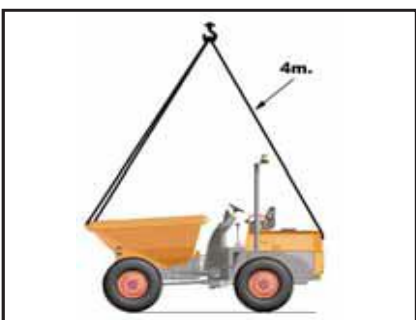

(fig. 4)

■ Loading the dumper onto a trailer by crane (fig. 1, 2, 3, 4)

If a sling and crane are used to load the vehicle onto a trailer or truck:

- Previously immobilise both parts of the chassis with the union bar foreseen for this purpose **(fig. 1)**
- Attach the sling as shown in the next figure.
- Fix the cable or slings in the products on the machine.
 - FRONT PART: by the ears welded on the bucket **(fig. 2)**
 - BACK PART: by the counterbalance. **(fig. 3)**
- Make operation with the unloaded dumper.
- Before lifting check that the sling cable is firmly attached this cable and the crane have enough capacity to handle the dumper.
- While lifting the dumper do not permit anyone to ride in the dumper or bystanders to stand within 5m (15ft).
- Make operation in plain and horizontal.
- Use the guide ropes or another systems to avoid the turnings dumper.

Bear in mind the following advice:

- the horizontal.
- Raise the machine in a balanced position.

Transporting the dumper

■ Towing the dumper

The towing of dumpers is only recommended in case of damage, when there is no other options. When possible, it is strongly recommended to solve the problem where the dumper id stopped. When is not possible, towing must be done at low speed and short distances.

Remove the parking brake.

Before towing the dumper should thoroughly crowd together the central screws of the valves of maximum pressure of the hydrostatic pump, to make it will loosen it the locknuts. **(fig. 1)**

Once the machine is repaired loose the central screws of the control valves of the hydrostatic pump and tighten again the lock nuts.

Drive slow and carefully without exceeding the speed of 10 Km/h (6 Mph), expiring with the regulation of the country in what concerns the towed one of a vehicle 4 x 4 in roads and rapid routes.

If the dumper must be towed for short distances, only do so with a solid tow-bar to prevent any lateral sway and always with the chassis stringed with the union bar included. **(See fig. 1 previous page).**

	ADVERTENCIA	
Do not tow this dumper behind a car or other vehicle.		



(fig. 1)



Fluids and lubricants

This section specifies the recommended liquid and lubricants. See the "MAINTENANCE CHART" on this Manual for the recommended change / service intervals.				
FLUID OR LUBRICANT	SPECIFICATION	REMARKS	AUSA P/N	CAPACITY (Liters)
FUEL	Use clean auto diesel (class A), preferably in accordance with Directive 98/70/EEC modified by directive 2003/17 or Standard EN 590 equivalent to the same. In Spain this corresponds to RD 1728/1999. For the USA market, it should conform to Grades 1D and 2	See FUEL on this section		45
ENGINE OIL	Engine oil in accordance with MIL- 2104C / API CD or higher	See section ENGINE OIL in this section	461.00017.00	9.5
ENGINE COOLANT	Ethylene glycol antifreeze with corrosion inhibitors for aluminum engines with internal combustion. 50% glycol / 50% distilled water in Standard machine.	See section ENGINE COOLANT in this section	45.00075.01	7.5
HYDRAULIC CIRCUIT	Hydraulic oil ISO Grade VG-46 in accordance with ISO 6743/4 HV DIN 51524 Part 3 - class HVLP	See HYDRAULIC CIRCUIT in this section	461.00008.00	45
DIFFERENTIAL FRONT AXLE OIL	Oil for transmission SAE 85W/90 in accordance with API GL4 LS (Limited Slip).	See AXLES OIL in this section	461.00016.00	4.1
FRONT AXLE WHEEL HUB REDUCTION OIL				0.35
REAR AXLE AND TRANSFER BOX	Oil for transmission SAE 85W/90 in accordance with API GL4		461.00004.01	4.7
BRAKE FLUID	Mineral brake fluid LHM (green) in accordance with ISO VG32.	See BRAKE FLUID in this section	461.00001.01	1
BATTERY ELECTROLYTE	Distilled Water	See section BATTERY ELECTROLYTE in this section		
GREASING POINTS	Calcic grease NLGI-3 consistency	See section LUBRICATION POINTS in this Operator's Manual	461.00009.00	

Fluids and Lubricants

■ Fuel

Use clean petrol class A preferably according to the Directive 98/70/CEE modified by the directive 2003/17 or the equivalent Standard EN 590 which is RD 1728/1999 in Spain.. For the market in the USA, it must meet the Grades 1D and 2D of ASTM D975. If supplies don't meet this Grades, their mass should never content more than 0.5% sulphur. The use of biodiesel type REM is not recommended. When used, its proportion cannot be more than 5% of the petrol mixture.

■ KUBOTA engine oil

Use 4- stroke engine oil that meets or exceeds the requirements MIL-L-2104C / API CD. Verify always the quality API in the attached etiquette in the container of the oil to make sure that the quality should be the needed one.

Your machine leaves the factory with SAE 20W40 viscosity. However, and in accordance to the climate, refer to the following chart (**fig. 1**) to select the proper viscosity:

If you use oils of different brands, empty completely the housing before adding the new oil.

■ Coolant

Always use ethylene-glycol antifreeze containing corrosion inhibitors specifically for internal combustion aluminum engines.

Cooling system must be filled with distilled water and antifreeze solution (60% water, 40% antifreeze in standard machine for temperatures of -17°C up to 127°C) (50% water, 50% antifreeze for temperatures of -35°C up to 145°C).

■ Hydraulic Circuit

- VG 32 for environmental temperatures normally below 10°C.
- VG 46 for environmental temperatures between 10°C and 40°C.
- VG 68 for environmental temperatures normally above of 40°C.

■ Rear axle oil

The recommended oil by the manufacturer is:
BP ENERGEAR HYPO 80W-90.

Also they can use the following oils:

- MOBILUBE HD90
- CASTROL DEUSOL EP90.
- SHELL SPIRAX 90EP.

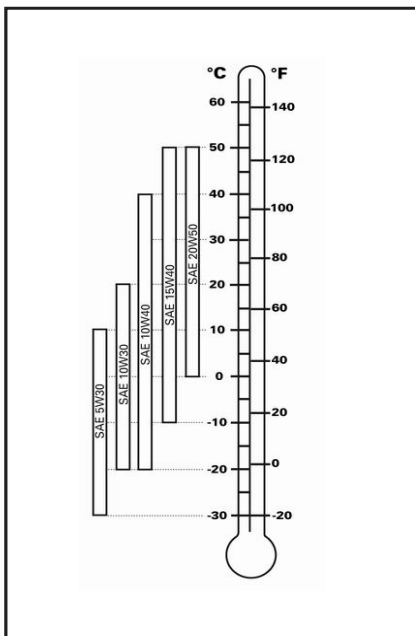

(fig. 1)



Fluids and lubricants

■ Front axle oil

SAE 85W90 API GL4 LS (limited slip) oil with additives for oil-bath brakes

CAUTION:

For a proper performance of the brake do not use oils other than recommended or mix different oils for topping up.

You can also use the following oils:

- Mobilfluid 422
- ESSO torque fluid type 56 or 62
- Agricastrol AS special
- Gulf universal tractor oil

■ Brake fluid

Liquid brakes type (green) LHM of mineral base according to ISO VG32.

CAUTION:

To avoid serious damage to the braking system, do not use fluids other than the recommended one, nor mix different fluids for topping up. Under no concept use liquid of brakes of vegetable base (SAE J1703).

■ Battery electrolyte

This dumper is equipped with a type battery that requires maintenance. Add distilled water for missing electrolyte.

Special procedures

1.- Engine Overheat

If engine overheats and indicator light turns on, try the following:
Check and clean radiator fins. See PERIODIC MAINTENANCE OPERATIONS section in this Manual.

WARNING:

The radiator can be very hot, wear gloves before touching radiator.

Reduce vehicle speed but try to keep vehicle moving to supply air to radiator.
If engine is still overheating after approximately one minute, stop dumper, set the gearbox lever or the directional control switch in neutral gear, apply the parking brake and stop engine.
Let engine cool down. Check coolant level and refill if possible.
If the engine continuous to overheat see an authorized AUSA dealer as soon as possible.

2.- Post-Operation Care

When dumper is used in salt-water environment (beach area, etc.), rinsing the vehicle with fresh water is necessary to preserve dumper and its components.
Metallic parts lubrication is highly recommended.
This must be performed at the end of each operating day.
When dumper is operated in muddy conditions, rinsing the dumper is recommended to preserve it with water and to keep lights clean.

NOTE: Never use the high pressure washer to clean the dumper **USE LOW PRESSURE ONLY.** The high pressure can cause electrical or mechanical damages.

3.- Overturned

In case that the dumper was overturning:
The driver must avoid remain caught between the machine and the soil. For it we recommend:

- Try to be kept inside the cockpit of the operator.
- Take hold firmly the steering wheel.
- Support firmly the feet on the sheet.
- Try to be kept as remote as possible of the point of impact.

When vehicle is turned over or stays tilted on the side, replace the vehicle in its normal operating position (on all four wheels).



Special procedures

ATTENTION!

DO NOT ATTEMPT TO TURN ON THE DUMPER without previously consulting an authorized AUSA distributor.

- Disassemble pre-heating spark plugs.
- Turn the key of the starter to the position (C) (**see fig. 1 page 19**). Keep the keys in this position until the oil has gone out of the combustion chambers.

ATTENTION!

The oil will come out at high pressure and this could cause injuries.

- Mount the pre-heating spark plugs again.
- Check engine oil level and refill if necessary. If the pressure indicator is on after starting the engine, turn it off straightaway in order to avoid internal damage and consult an authorized AUSA distributor, who will find out the cause.

4.- Dumper immersion

Should the dumper become immersed, it will be necessary to take it to an authorized AUSA dealer as soon as possible.

ATTENTION!

DO NOT START THE ENGINE. Immersion of the dumper can cause serious damage if the correct re-start procedure is not followed.

Have an authorized AUSA dealer inspect supply system integrity as specified in MAINTENANCE CHART.

5.- Storage and Preseason Preparation

When a dumper is not in use for more than one month, proper storage is a necessity.

When using your dumper after storage, a preparation is required.

See an authorized AUSA dealer for proper procedures.

Periodic maintenance operations

- **In maintenance operations use only original AUSA parts. Is the only way to guarantee the same technical level as new.**

- In this dumper as in all machine, there are some parts subjected to wear and breakdown, affecting safety, and environment, like gas emissions, etc. Periodic revisions are necessary to keep everything in good shape.

As established by Works Team Guidelines, inspections must be effected in those systems and the results registered on those forms predicted by Labour Authorities of each country.

(89/655/GEE and RD1215/97).

Unless otherwise specified, engine should not be running for all maintenance procedures.

In the case of doing a repair with the engine on, all the repairs and operations of maintenance must be done with the dumper unloaded, the gearshift or the directional control switch in neutral position and the wheels blocked to maintain the dumper immobilised.

Always disconnect the battery before conducting any operation in the electrical system by using the disconnecter (**fig. 1**) which can be found in the battery's negative terminal (-) Never use a flame to verify the level of the liquids.

- **Be environmentally friendly**

When changing oil and other fluids, use an appropriate container, and don't harm the environment during the operation and take old elements (battery, coolants, tyres, etc) to recycling centres that correspond. In case of escapes of dangerous substances for people or environment, try to minimise their impact. For example, in oil escapes, block the leak, put a container to collect the fluid, spread absorbent material or pick up polluted mud if necessary.

- **To clean the dumper**

During cleaning operations, don't direct the flow of water directly to air intake, battery, instrument board, alternator and other electric equipments because they can cause damages.

- **Breakdown in road**

In case of breakdown when driving on public roads, warn other users of the road with the hazard warning triangles. These triangles are offered as optional equipment.



(fig. 1)



Periodic maintenance operations

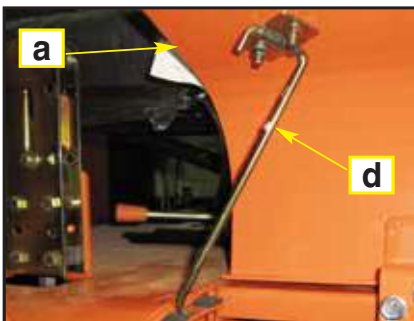

(fig. 1)

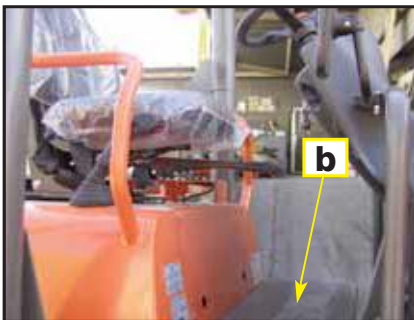

(fig. 2)



(fig. 3)



(fig. 4)

■ Access from maintenance. (fig. 1, 2, 3)

The engine, the transmission and filters are located underneath the lateral covers in the back part of the machine (fig. 1) and underneath the footrest plate (fig. 2). To access them, we must proceed as it follows:

- a. Engine cover
- b. Footrest plate.
- c. Engine cover lock.
- d. Engine cover support rod.

To lift the lateral covers, lift up the lock and turn it to the right (fig. 3). Lift the cover (right or left) pulling it. There are rods (d) to maintain it in the upper position.

To gain access to the footrest plate, loose the fixation screws and remove the cover.

■ Lock to avoid hopper's descent. (fig. 4)

In the lower part of the hopper there is a lock to keep the hopper elevated in maintenance operations. Following these instructions, the machine should be repaired with total security.

e. Hopper elevated lock.

■ Security of the chassis joint. (fig. 5)

Before carrying out any intervention forcing you to be between the two parts of the chassis, immobilise the joint with the foreseen emergency rod.

f. Security of the chassis joint.

ATTENTION!

Should removal of a locking device (e.g. lock tabs, self-locking fasteners, etc.) be required when undergoing disassembly/assembly, always replace with a new one.

The initial maintenance is very important and must not be neglected. See MAINTENANCE CHART in this Manual.

The following covers the maintenance items that can be performed by the customer if desired.

Other items found in maintenance chart must be performed by an authorized AUSA dealer. See MAINTENANCE CHART in this Manual.

■ Safety prop for high-tipping system frame (only on AHGA model) (fig. 6)

In the upper part of the turning crown there is a safety prop to carry out maintenance operations with the high-tipping system frame (scissors) lifted and avoid undesired falling down. Following these instructions, the machine should maintain fully safety.

g. high tipping frame safety prop LOCKED

WARNING

Before Attempting to Carry out any work under a raised skip or high tipping frame system, props (e) y (g) must be placed in its LOCKED position.

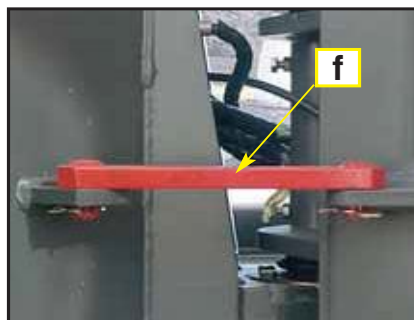

(fig. 5)



(fig. 6) AHGA

Periodic maintenance operations

1.- Engine

For information on correct operation, spare parts and general maintenance, see separate ENGINE MANUAL. Also review the MAINTENANCE CHART in this Manual.

■ Alternator belt

Control periodically the tension of the alternator belt. Also, verify if there are cracks or other damages. See an authorised AUSA dealer to replace the alternator belt.

2.- Supply circuit.

CAUTION:

Never mix oil with fuel. This vehicle has a 4-stroke engine. Oil must be added to engine base only.

Use clean petrol class A preferably according to the Directive 98/70/CEE modified by the directive 2003/17 or the equivalent Standard EN 590 which is RD 1728/1999 in Spain.

For the market in the USA, it must meet the Grades 1D and 2D of ASTM D975. If supplies don't meet this Grades, their mass should never content more than 0.5% sulphur.

The use of biodiesel type REM is not recommended. When used, its proportion cannot be more than 5% of the petrol mixture.

The current regulations of exhaust emissions, require that, for the whole life of the machine, the level on the different components of these emissions, are under the maximum figures stated on the regulations.

As a consequence of that, the maintance plan of the engine has to be followed carefully, giving special attention to the quality and pureness of the fuel, the cleanness of the filters and, in general, to the general maintenance of the fuel circuit

■ Fuel level (fig. 1, 2)

The fuel tank is located on the right side of the engine compartment.

The gauge shows an approximate amount of the fuel in tank.

a. Fuel gauge.

b. Fuel filler cap.

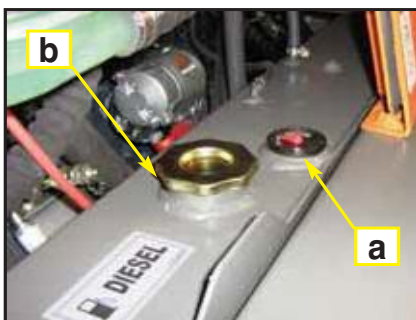

(fig. 1)

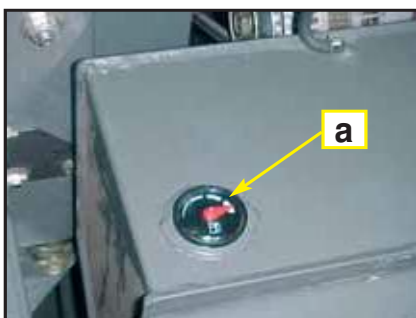

(fig. 2)

	WARNING	
<p>Always stop engine before refueling. Open cap slowly. If a differential pressure condition is noticed (whistling sound heard when loosening fuel tank cap) have vehicle inspected and/or repaired before further operation. Fuel is flammable and explosive under certain conditions. Never use an open flame to check fuel level. Never smoke or allow flame or spark in vicinity.</p> <p>Always work in a well ventilated area. Never top up the fuel tank before placing the vehicle in a warm area. As temperature increases, fuel expands. If the fuel tank is completely full, the fuel can overflow by the air vent. Always wipe off any fuel spillage from the dumper.</p>		



Periodic maintenance operations

■ Drainage of the fuel tank.

c. Reservoir drain plug. (fig. 1)

The drain of the tank have to make by the plug located in the inferior side of the tank.

- Clean the tank drain plug area.
- Place a drain pan under the oil drain plug area.
- Unscrew plug.
- Change gasket on oil drain plug. Clean gasket area on engine and oil drain plug then reinstall plug.

Ensure oil drain plug areas are not leaking.

ATTENTION!

Wipe off any spillage on fuel.

■ Change fuel pre-filter. (fig. 2)

NOTE: Always replace this component. Never try to clean it.

Accede to the back inferior part of dumper under the counterbalance of the engine as it follows:

d. Pre-filter e. Flanges

Disassemble the fixation bridles and the filter. Make sure that the new filter is mounted in the correct sense as indicates the arrow marked in the body of the filter.

■ Change fuel filter.

Unscrew the fuel filter located in the right side under the sheet.

f. Fuel filter. (fig. 3)

Clean the base and grease with clean oil the joint of the new filter. Screw the filter element and tighten it without using mechanical means.

ATTENTION!

- Wipe out any fuel spillage on engine.
- Start engine and let idle for a few minutes.
- Ensure fuel filter area are not leaking.
- Stop engine.
- Reject the filter cartridge and the dirt fuel in the authorised centers.
- Precaution must be taken to tighten correctly the fuel filter otherwise the feeding system could suck outside air causing failures in the engine.

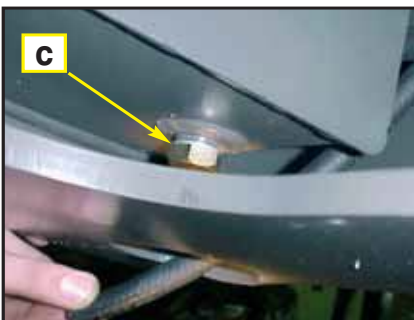

(fig. 1)

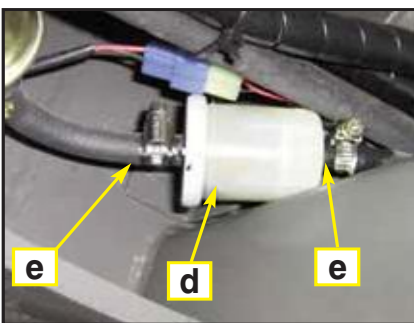

(fig. 2)



(fig. 3)

Periodic maintenance operations

■ Purge of the circuit of nourishment.

If the circuit of nourishment has taken air, it is not necessary to drain the circuit, since it has a system that gives out the air within the circuit.

ATTENTION!

Precaution must be taken to slack correctly the drainage (g) otherwise its could causing failures in the engine.

3.- Engine oil.

■ Engine Oil Level (fig. 2, 3 and fig. 1 next page)

CAUTION:

Check level frequently and refill if necessary. Do not exceed the maximum mark. Operating the engine with an improper level may severely damage engine. Wipe off any spillage.

With the dumper on a level surface and engine hot, not running, check the oil level as follows:

a. Level rod.

- Pull the level rod, remove it from its lodging and clean it with a clean cloth. **(fig. 2)**
- Place the level rod in its lodging.
- Remove and check oil level. It should be near or equal to the upper mark overfill. **(fig. 3)**

b.- Full

c.- Add

d.- Operating range

- Add oil up to upper mark if required.
- To add oil, remove dipstick. Place a funnel in the oil filling orifice located in the left part of the engine, behind the air filter.

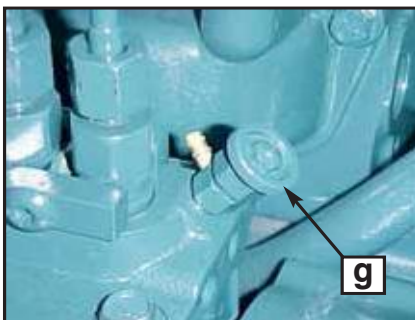

(fig. 1)

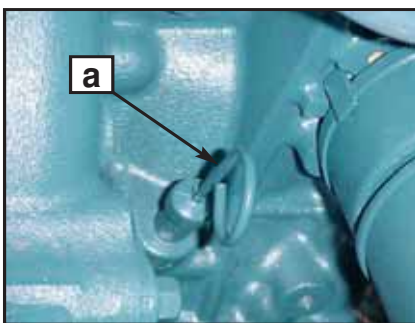

(fig. 2)

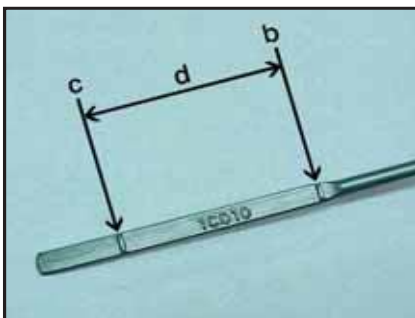

(fig. 3)



Periodic maintenance operations

e. Filling orifice. (fig.1)

Do not exceed the maximum mark .

- Cover correctly the oil filling orifice and place correctly the level rod.

■ Oil Change and Oil filter Replacement. (fig. 2, 3)

The change of oil and oil filter must be carried out in the timings stated in the MAINTENANCE CHART.

ATTENTION!

The first substitution of the oil of the engine must be done after the first 50 hours of service. The initial maintenance is very important and must not be neglected.

- Oil change should be done with a warm oil.
- Ensure vehicle is on a level surface.
- Remove dipstick.
- Clean the oil drain plug area.
- Place a drain pan under the oil drain plug area.
- Unscrew oil drain plug.

f. Oil drain plug.

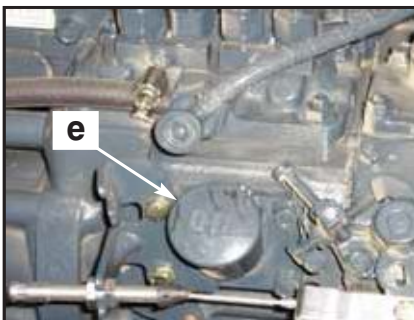

(fig. 1)

	WARNING	
<p>The engine oil can be very hot. To prevent burning yourself, do not remove the engine drain plug or the filter cover if the engine id hot. Wait until engine oil is warm.</p>		

Allow enough time for oil to flow out.

Unscrew the oil filter cover, located on the left side and remove.

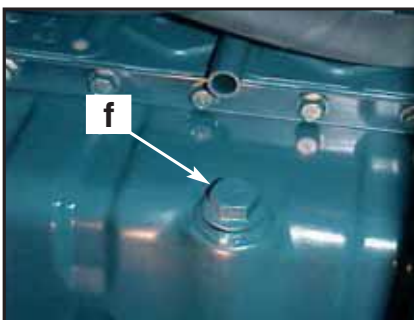

(fig. 2)

g. Oil cartridge filter. (fig. 3)

Clean the base and grease with clean oil the joint of the new filter element. Screw the filter element and tighten it without using mechanical means.

ATTENTION!

- Wipe out any oil spillage on engine.
- Change gasket on oil drain plug.
- Clean gasket area on engine and oil drain plug then reinstall plug.
- Refill engine at the proper level with the recommended oil.
- Refer to FLUIDS AND LUBRICANTS for capacity.
- Start engine and let idle for a few minutes.
- Ensure oil filter area and oil drain plug areas are not leaking.
- Stop engine.
- Wait a while to allow oil to flow down to crankcase then check oil level.
- Refill as necessary.
- Reject the used oil in the authorized centers.

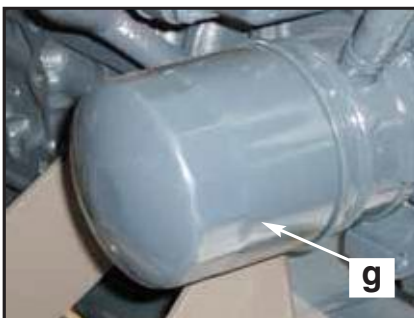

(fig. 3)

Periodic maintenance operations

4.- Engine refrigerating circuit.

Refer to FLUIDS AND LUBRICANTS in this Manual for the specifications of the cooler to be used.

WARNING

Never remove the cap of the expansion tank when the engine is hot, Wait until engine is cold. Wait 20 minutes aprox.

Never remove the cap of the expansion tank when the engine is hot, Wait until engine is cold. Wait 20 minutes aprox.

■ **Coolant level. (fig. 1)**

Verify through the expansion tank.

a. Expansion tank.

Upper the right lateral cover.

With vehicle on a level surface, liquid should be between MIN. and MAX. level marks of the expansion tank.

NOTE: When checking level at temperature lower than 20 °C (68 °F), it may be slightly lower than MIN. mark.

Add coolant up to MAX. mark if required. Never do not overfill to MAX. mark.

Use a funnel to avoid spillage.

Properly reinstall and tighten filler cap and close the cover.

NOTE: A cooling system that frequently requires coolant is the indication of leaks or engine problems. See an authorised AUSA dealer.

■ **Replacement refrigerating liquid (fig. 1, 2).**

b. Drainage cock of cylinder block.

c. Lower muff of the radiator.

The change is to be made every 1000 hours or when the circuit must be emptying. To make this, follow next steps:

- Open the drainage cock of cylinder block, located at the left side of the engine, for emptying.
- Disassemble the inferior muff of the radiator to drain the radiator by this point.
- Before opening the circuit we must close the drainage cock of engine and assemble the muff again.
- Filling is done by the expansion tank.
- Start the engine until the thermostat is opened.
- Then with the cold engine, the level of the expansion tank must be checked.

Check periodicity of renovation in MAINTENANCE CHART or when the circuit must be emptying.



(fig. 1)

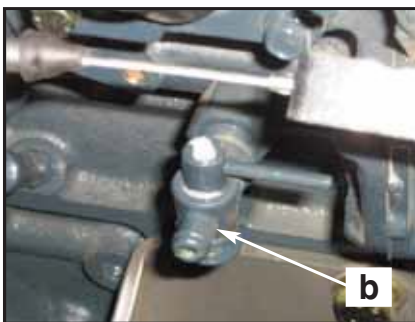

(fig. 2)

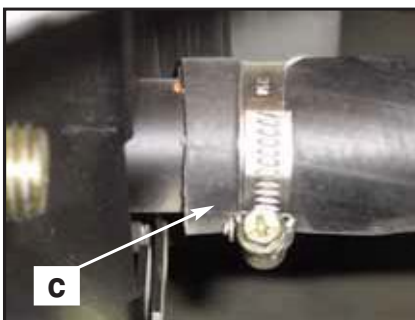

(fig. 3)



Periodic maintenance operations

■ Radiator. (fig.1)

Periodically check the radiator area for cleanliness.

d. Radiator fins.

Inspect radiator fins. They must be clean, free of mud, dirt, leaves and any other deposit that would prevent the radiator to cool properly.

Never clean radiator with your hands when it is hot. Use gloves to clear the external wastes of the radiator. Let the radiator cool down before cleaning.

If possible, use water to clean the cooling fins of the radiator with a hose.



WARNING



WHEN HOSING, NEVER USE A HIGH PRESSURE WASHER, ALWAYS USE A LOW PRESSURE WASHER.

Be careful not to damage the radiator fins when cleaning. Do not use any object/tool that could damage the fins. The fins are purposely thin parts to allow efficient cooling.

See an authorised AUSA dealer to check the performance of the cooling system.

5.- Air Intake System.

■ Air Filter Cleaning. (fig. 2)

The engine uses a dry type filter with double element. Correct maintenance of the air filter is essential for the engine performance as well as to the life of the engine.

Check periodicity of renovation in MAINTENANCE CHART.

The inner element of the filter must be replaced each 2 substitutions of the outer element.

NOTE: If vehicle is used in dusty area, inspect more frequently than specified in MAINTENANCE CHART.

NOTE: The filter has a clogging indicator (vacuummeter). If this indicator in the control panel is lit, the filter element should be serviced as soon as possible.

CAUTION:

Do not start engine when water is found into the air filter box.

When water/deposits are found, the air filter must be inspected/dried/replaced depending on its condition.

Remove air filter as explained below.

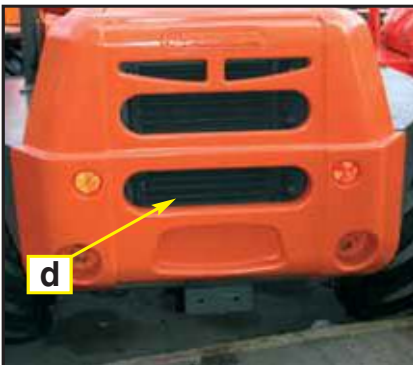

(fig. 1)



(fig. 2)

D 250 AHG / D 250 AHGA



Periodic maintenance operations

■ Air Filter Removal. (fig. 1, 2, 3, 4)

CAUTION:

Never remove or modify any component in the air filter. Otherwise, engine performance degradation or damage can occur.

Accede to the filter through the left lateral cover.

- a. Clamps.**
- b. Filter element.**
- c. Housing.**

Release the filter staples of the housing and remove the filter elements. To clean the filter element of accumulated dust dirt, and remove the filter element and from the inside, while turning, blow out the element using air line with pressure not exceeding (maxim 5 bar/60psi).

Clean inside the filter housing.

■ Air Filter Installation.

Properly reinstall removed parts in the reverse order of their removal.

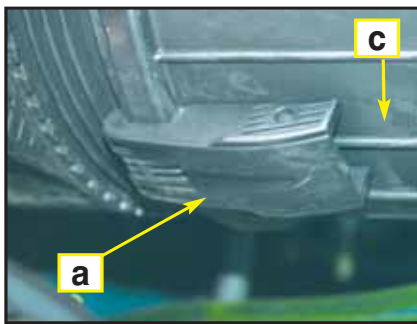

(fig. 1)



(fig. 2)

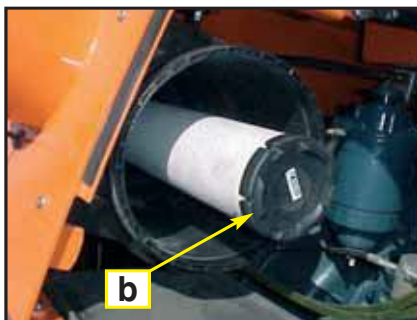

(fig. 3)



(fig. 4)

46



D 250 AHG / D 250 AHGA

Periodic maintenance operations

6.- Transfer box (fig. 1)

■ Oil level in the transfer box

a. Level cap.

With vehicle on a level surface and engine cold, check the oil level as follows:

- Unscrew the level cap. The oil must overflow by the hole.
- If necessary, add oil by the level hole.

■ Change of the transfer box oil.

Change should be done with a warm oil.

Clean the oil drain plug area.

Place a drain pan under the oil drain plug area.

Unscrew oil drain plug.

b. Oil drain plug.

- Clean transfer-box area on engine and oil drain plug then reinstall plug.
- Refill transfer-box at the proper level with the recommended oil. Refer to FLUIDS AND LUBRICANTS in this Manual for capacity.
- Ensure oil filter area and oil drain plug areas are not leaking.

ATTENTION!!

Wipe out any oil spillage on engine.

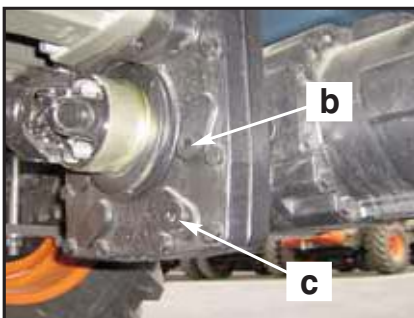

(fig. 1)

Periodic maintenance operations

7.- Differential axles. (fig. 1, 2)

REMARK: The transfer box is part of the rear axle and the fillin, level, drain and breeder plugs are common for both components.

■ Oil level of the differentials axles.

a. Level cap.

With vehicle on a level surface and engine cold, check the oil level as follows:

- Unscrew the level cap. The oil must overflow by the hole.
- If necessary, add oil by the breather cap or by the same level cap.

■ Differential axles oil replacement.

Oil change should be done with a warm engine.

Clean the oil drain plug area.

Place a drain pan under the oil drain plug area.

Unscrew oil drain plug

b. Oil drain plug.

Change gasket on oil drain plug. Clean gasket area on engine and oil drain plug then reinstall plug.

Refill differentials axes at the proper level with the recommended oil. Refer to FLUIDS AND LUBRICANTS in this Manual for capacity.

Ensure oil filter area and oil drain plug areas are not leaking.

ATTENTION!

Wipe out any oil spillage on engine.

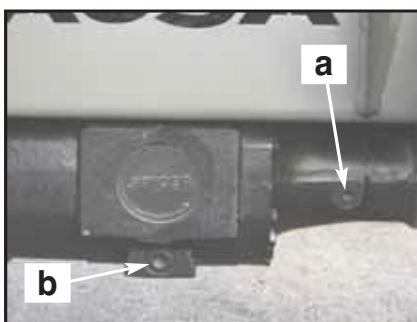

(fig. 1)

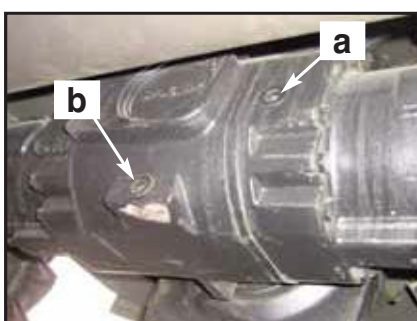

(fig. 2)



Periodic maintenance operations

■ Wheel hub (only front axle)

c. Wheel hub plug

For topping up of the wheel hub, use plug (d). Turn the hub until the text "Oil stand-Oil level" is in horizontal position (**as shown on fig. 2**).

Loose the plug and fill in until the oil spills out of the hole. To drain the oil turn the hub until the plug is in the lowest position.

CAUTION!

To prevent serious injuries, do not remove the plug on the lowest position when the oil is warm. Always place the plug in the upper position (**as shown in fig. 1**), remove the plug and then turn the hub until reach the desired position (**fig. 3**). See the "MAINTENANCE CHART" for manitenance details.

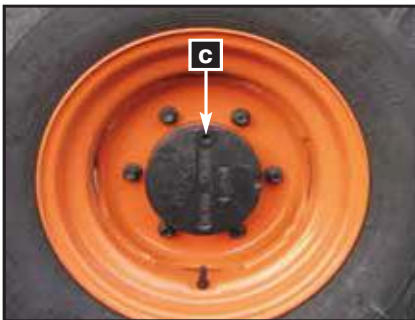

(fig. 1)



(fig. 2)



(fig. 3)

Periodic maintenance operations

8.- Service brake and Parking brake.

Verify the following to maintain the brakes in good conditions of operation:

- Losses of liquids in the system.
- Smooth sensation of the pedal and non blocking of it.

ATTENTION!

The brake fluid replacement or any brake system repairs should be performed by an authorised AUSA dealer.

■ Parking brake.

When using the parking brake if this one does not immobilise the vehicle, the cables must be tighten; to do so:

a. Cable housing.

Tightening of the handbrake (fig. 1, 2)

- Can be tightened by both ends of the cable housing.
- Always maintain cables without excessive dubbings and the link lubricated.

■ Service brake.

These brakes are self-adjusting and require no adjustment.

■ Brake fluid level. (fig. 3)

The tank is located upon the brakes pump, under the sheet floor.

b. Brake fluid tank.

With dumper on a level surface, liquid should be between MIN. and MAX. level marks.

NOTE: Do not exceed the maximum mark.

Use a funnel to avoid spillage.

Place and tight the filling cap appropriately.

NOTE: A system of brakes that requires frequently brakes liquid, indicates that losses exist. See an authorised AUSA dealer.

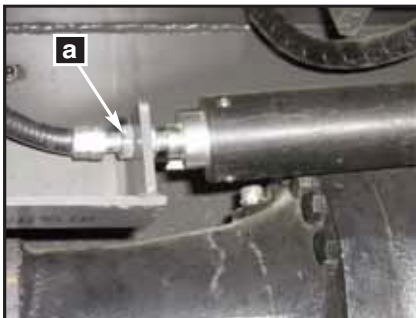

(fig. 1)

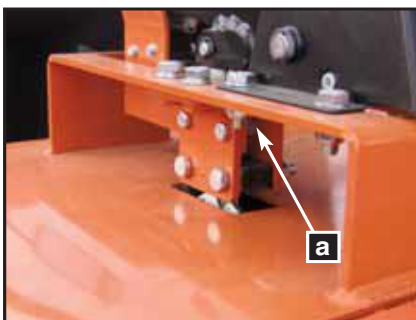

(fig. 2)



(fig. 3)



Periodic maintenance operations

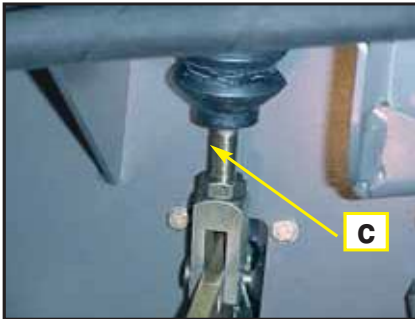

(fig. 1)



(fig. 2)



(fig. 3)

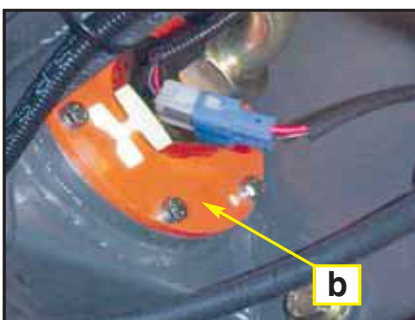

(fig. 4)

■ Change of the brakes liquid.

Consult the periodicity of renovation, in the MAINTENANCE CHART or when due to a repair, the circuit has to be drained. To do so, contact with an authorized AUSA dealer.

■ Brake pump. (fig. 1)

If the pedal has an excessive free movement, it is possible to corrected it regulating the pusher of the pedal commanding the brake pump, this one has a nut system lock.

c. Pump pusher.

The pusher must have a free movement between 1 and 1.5 mm, making sure that the pump is free of internal pressure.

9.- Hydraulic Circuit.

■ Level of the hydraulic oil (fig. 2, 3)

The deposit of the hydraulic oil is located in the left side of the engine compartment.

Ensure vehicle is on a level surface.

The oil level has always to be verified with the hopper in the low position and with the engine stopped.

a. Cap of filling and rod of level.

To uncoil the cap of filling (1) that includes the level rod . The oil must be between the mark of MIN and MAX level.

If necessary, add oil by the same hole. Use a funnel to avoid spillage.

Properly reinstall and tighten filler cap and close access panel.

NOTE: Do not exceed the maximum mark.

NOTE: An hydraulic system requiring oil frequently indicates that losses exist. See an authorised AUSA dealer.

■ Change of the hydraulic oil. (fig. 4, 5)

b. Aspiration filter.

c. Cap of the tank.

The draining the deposit is made by the cap located in the inferior part of the deposit. Clean the zone of the oil draining cap.

Put a container underneath the zone of the of the oil draining cap.

Unscrew the cap.

There is an aspiration filter In the hydraulic circuit, located in the interior of the tank. It is a metallic filter that must be cleaned whenever the hydraulic oil is replaced.

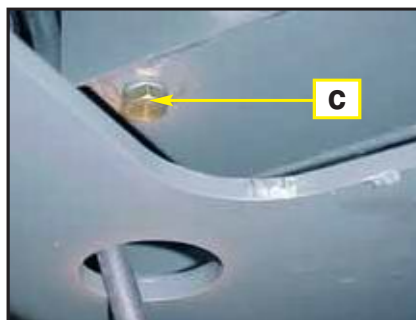

(fig. 5)

Periodic maintenance operations

Change gasket and clean the magnet of oil drain plug. Clean gasket area the deposit and oil drain plug then reinstall plug. Refill the deposit at the proper level with the recommended oil. Refer to FLUIDS AND LUBRICANTS in this Manual for capacity. Ensure oil filter area and oil drain plug areas are not leaking

ATTENTION!

Wipe out any oil spillage on engine.

■ Filter of the hydrostatic transmission (fig. 1, 2, 3)

The hydrostatic diagram is equipped with a cartridge filter. Replace it as regularly as it is indicated in the "MAINTENANCE CHART".

The support of the filter goes provided of an obturation indicator (vacuummeter) (d). With the engine started, the needle has to be located in the green area or as maximum in the yellow one. If it comes closer or it locates in the red area, to replace the cartridge filter as soon as possible.

- d. Vacuummeter**
- e. Oil Tap**
- f. Cartridge filter**

■ Cartridge filter substitution.

Turn off the tap (e).

Loose the filter (f). Clean the base and grease with clean oil the joint of the new filter. Screw it in its support and tighten it without using mechanical means.

Turn on the tap again (e).

ATTENTION!

Remember to open the oil tap again and to fasten the cartridge filter properly (f), otherwise it would cause fatal damage to the hydrostatic transmission.

■ Security valves regulation. (fig. 4, 5)

There are two security valves to avoid overpressures in direction and operating circuits.

- g. Valve of the hydraulic direction circuit.**
- h. Driving circuit security valve.**

First of them is located in the hydraulic direction and the second one is in the distributor. Those valves are pre-regulated at correct pressure, but periodically they have to be checked and regulated again if necessary. However this work must only be done by trained mechanics with knowledge of hydraulics and correct pressure gauge tools. The pressure must not be set higher than set forth in SPECIFICATIONS in this Operators Manual.

- Valve of the hydraulic direction circuit: Take off the cap and turn the screw underneath clockwise to increase the hydraulic pressure and the opposite to reduce it.
- Driving circuit valve: This valve is located on the load control. Take out the cover nut and turn the screw underneath clockwise to increase the hydraulic pressure and the opposite to reduce it.



(fig. 1)



(fig. 2)

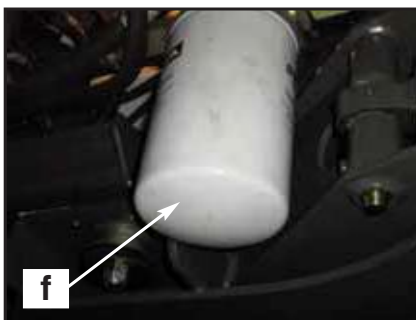

(fig. 3)



(fig. 4)

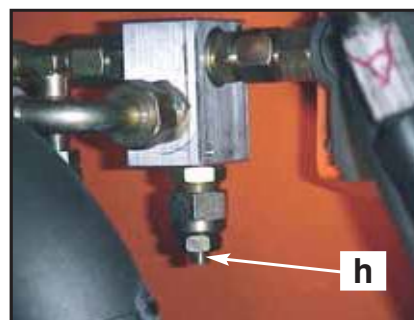

(fig. 5)



Periodic maintenance operations



(fig. 1)

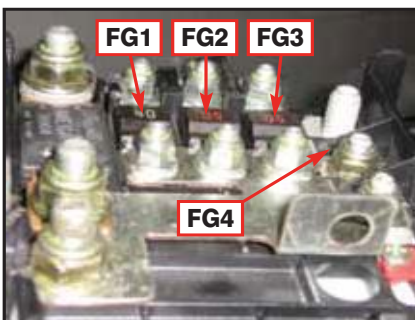

(fig. 2)

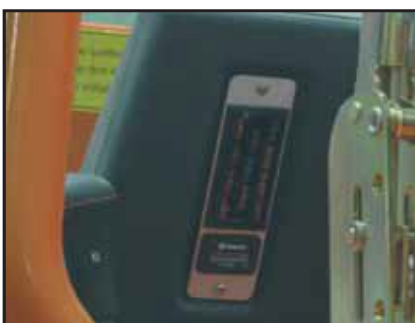

(fig. 3)

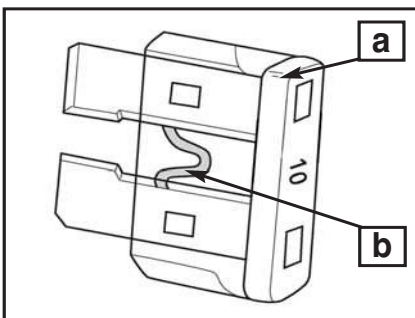

(fig. 4)

Hydraulic sleeves

All the hydraulic sleeves must be replaced at least every 6 years.

10.- Electric circuit.

Battery

The battery is located under the sheet in the left side.

Verify that the battery does not have external damages, raised plates or losses of electrolyte.

Verify the density of the electrolyte. The value must be between 1.27 and 1,28.

Clean oxide residue from the battery tips.

Apply dielectric grease on post to protect against oxidation.



WARNING



Never charge a battery while installed in dumper.

Battery disconnect. (fig. 1)

There is a battery disconnect located in the negative tip (-).

It is recommended to disconnect the battery during repairs in the electrical system, welds and between long periods of storage.

Fuses.

If a fuse is damaged, replace it by one of the same rating.

CAUTION:

Do not use a higher rated fuse as this can cause severe damage.

Fuses are located on a box in the back part of the battery and the Control Panel and controls in front of the operator.

Box fuses on the battery positive tip. (fig. 2)

FG1: - (80A) **FG2:** - (50A) **FG3:** - (30A) **FG4:** - (Optional)

Instruments panel and controls fuses. (fig. 3)

F1: (+30) hazard lights fuse (75A).

F2: Reverse alarm / side lights fuse (5A).

F3: Side lights fuse (5A)

F4: Low beam fuse (10A)

F5: High beam fuse (10A)

F6: Parkbrake switch fuse (75A)

F7: Forward / Reverse solenoid fuse (10A).

F8: (+15) Alternator / Engine stop solenoid fuse (10A) **(only AHG model).**

(+15) Alternator / Engine stop solenoid fuse / High tipping solenoid fuse (15A) **(only AHGA model).**

F9: Dashpanel lights fuse (75A).

F10: Rotating beacon / Working lights fuse (15A)

F11: Optional fuse (10A).

To remove fuse from holder, remove the fuse holder cover then pull fuse out.

Fuses check. (fig. 4)

Check if filament is melted.

TYPICAL

a. Fuse

b. Check if melted

Periodic maintenance operations

11.- Wheels.

If not essential because of the specific job to do, solid tyres or strips are not recommended because the effect of impacts are bigger about transmission and operator.

Occasionally, wheel nuts should be removed to apply anti-seize lubricant. This operation is particularly important when dumper is used in salt-water environment or in mud. Remove one nut at a time, lubricate then return to screw.

■ Wheels retighten.

Weekly, or every 50 running hours, the nuts of the wheels fixation have to be retighten.

Specified torque of wheel nuts: 330 Nm.

■ Tires Pressure.

ATTENTION!

Tire pressure greatly affects dumper handling and stability. A low pressure may cause tire to deflate and rotate on wheel. A high pressure may burst the tire. Always follow recommended pressure. Because the tyre pressure is high, do not use the manual pump. It is recommended that experienced tire personnel should only do tire inflation, as tire inflation can be dangerous if not done with care.

The following procedure steps should be taken when inflating the tires, with special caution exercised when working on the rear axle tires:

- Park the dumper on level ground and turn the engine off.
- Always inflate tyres before it has been operated and the tires are still cold. Only inflate tires to the level recommended in SPECIFICATIONS in this Operators Manual.
- Tire pressure changes with temperature and altitude. Return to verify the pressure if one of these conditions has changed.
- Check tire air pressure with a tire pressure gauge. The inflation valve must be secured with a clamp to prevent a possible whip lash if the valve is suddenly disengaged.
- Always wear gloves to prevent injury from an unforeseen air jet.
- If a tire is inflated after being removed from the dumper, the tire should only be inflated after it has been placed under a protective cage.
- It is advisable to carry a puncture-proof kit.

■ Tire/Wheel Condition

Check tire for damage and wear. Replace if necessary.

Do not rotate tires if they are directional.

Their rotation must be kept in a specific direction for proper operation.

■ Wheel Removal (fig. 1)

Loosen nuts then lift dumper. Place a support under vehicle. Remove nuts then remove wheel.

At installation, it is recommended to apply anti-seize lubricant on threads.

Gently tighten nuts in a criss-cross sequence then apply a final torque of 330 Nm.

a. Taper side of nut

ATTENTION!

Always use the recommended wheel nuts. Using a different nut could cause damages to the rim.

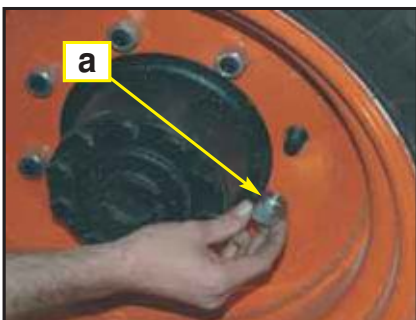

(fig. 1)



Periodic maintenance operations

12.- Cable Lubrication. (fig. 1)

All cables must be lubricated with cable lubricant.

ATTENTION!

Using another lubricant could cause bad working of throttle control/cable (throttle pedal, etc.). Always wear eye protection and gloves when you lubricate a cable.

13.- Body/Frame

■ Engine Area

Check engine area for any damage and leaks. Ensure all hose clamps are properly secured and no hose is cracked, kinked or otherwise damaged. Inspect exhaust, battery and reservoir fastening devices.

Check electrical connections for corrosion or fake connections.

Replace or have damaged parts repaired.

■ Chassis Fasteners

Check fastener condition and tightness on the dumper. Retighten as required.

■ Seat Belts

Check seat belts fixation and fastening. Inspect carefully the condition of this device with special attention to:

- Cuts or gossips in the tape
- Wear or damages in the ironworks including the points of anchorage.
- Badly functioning of the clasp of closing or of the winder.
- Seams or free points of sewing.

See an authorised AUSA dealer for parts replacement if damaged.

■ Vehicle Cleaning and Protection

Never use the high pressure washer to clean the vehicle USE LOW PRESSURE ONLY (like a garden hose). The high pressure can cause electrical or mechanical damages. Painted parts which are damaged should be properly repainted to prevent rust.

When required, wash the body with hot water and soap (only use mild detergent). Apply non-abrasive wax.

CAUTION:

Never clean plastic parts with strong detergent, degreasing agent, paint thinner, acetone, etc.



(fig. 1)



D 250 AHG / D 250 AHGA



Maintenance chart

	EVERY												To be performed by	
	Initial inspection (50 h)	Every 150 h.	Every 300 h.	Every 450 h.	Every 750 h.	Every 900 h.	Every 1500 h.	Every 3000 h.	Every week	Every 1 or 2 months	Every year	Every 2 years		
I: Inspect, verify, clean, lubricate, replace if necessary														
C: Clean														
L: Lubricate														
R: Replace														
ENGINE														
Oil (1)	R	R										R		CUSTOMER
Oil filter (1)	R		R											CUSTOMER
Alternator belt (1)		I		R									R	DEALER
Valve clearance					I									DEALER
FUEL SYSTEM														
Air filter element (4)		C		R(5)								R		CUSTOMER
Intake air line			I									R(6)		CUSTOMER
Fuel pipes and clamps										I		R(2)		DEALER
Fuel filter cartridge			R											CUSTOMER
Fuel prefilter (1)	R	R												CUSTOMER
Fuel tank and oil strainer				C										CUSTOMER
Fuel injection nozzle injection pressure (2)								I						DEALER
Injection pump (timing) (2)								I	I					DEALER
COOLING SYSTEM														
Radiator hoses and clamps bands			I									R		CUSTOMER
Water jacket (interior)				C										DEALER
Coolant										I		R		CUSTOMER
ELECTRICAL SYSTEM														
Battery electrolyte	I	I												CUSTOMER
Battery connections										I				CUSTOMER
Dash panel indicators / Warning lights (3)										I				CUSTOMER
Battery											I		R	CUSTOMER
Electric harness and loose connections												I		CUSTOMER
HYDRAULIC CIRCUIT														
Oil, drain plug magnet and suction strainer.	R/C							R/C			I			CUSTOMER
Hydraulic cartridge filter (1)	R							R						CUSTOMER
Bucket movements (3)										I				CUSTOMER
Pipes, hoses and fittings damages or leaks			I											CUSTOMER
Steering movements (3)										I				CUSTOMER
Hoses	REPLACE AT LEAST EVERY 6 YEARS												DEALER	

- (1) Initial inspection. The initial maintenance is very important and must not be neglected.
- (2) To be performed by an authorized AUSA dealer.
- (3) Daily inspection item.
- (4) More often under severe use such dusty area, sand, snow, wet or muddy conditions.
- (5) After cleaning 6 times.
- (6) replace only if necessary



56



D 250 AHG / D 250 AHGA

Maintenance chart

	EVERY										To be performed by			
	Initial inspection (50 h)	Every 150 h.	Every 300 h.	Every 450 h.	Every 750 h.	Every 900 h.	Every 1500 h.	Every 3000 h.	Every week	Every 1 or 2 months		Every year	Every 2 years	
I: Inspect, verify, clean, lubricate, replace if necessary														CUSTOMER
C: Clean														
L: Lubricate														
R: Replace														
GREASING POINTS														
Centre pivot									L				CUSTOMER	
Nipples (see section "GREASING POINTS" in this Manual)									L				CUSTOMER	
Controls and articulations (throttle, rams...)									L				CUSTOMER	
TRANSFER-BOX														
Oil (1)	R					R			I		R		CUSTOMER	
Oil leaks									I				CUSTOMER	
Screws and nuts torque									I				CUSTOMER	
AXLES (FRONT AND REAR)														
Differential oil (1)	R					R			I				CUSTOMER	
Wheel hub oil (1)	R					R			I				CUSTOMER	
Oil leaks									I				CUSTOMER	
Screws and nuts torque									I				CUSTOMER	
Chassis fixation screws (torque)						I							DEALER	
Wheel hub bearings adjustment						I							DEALER	
Cardan joint fixation screws (torque)										I			DEALER	
Flange fixation nut (torque)										I			DEALER	
Condition of tires and pressures									I				CUSTOMER	
BRAKES														
Brake fluid (3)						R			I				CUSTOMER	
Parking brake adjustment (3)	I								I				CUSTOMER	
BODY/FRAME														
ROPS frame									I				CUSTOMER	
Seat belt (3)									I				CUSTOMER	
Foot plate and access steps and handles (3)									I/C				CUSTOMER	
Guards and covers (3)									I				CUSTOMER	
Plates and decals (3)									I				CUSTOMER	
Centre pivot pin fixation nut						I							DEALER	
Safety system / chassis locking (connecting bar) and bucket safety lock									I				CUSTOMER	
Engine compartment cover locks									I				CUSTOMER	

(1) Initial inspection. The initial maintenance is very important and must not be neglected.

(2) To be performed by an authorized AUSA dealer.

(3) Daily inspection item.

(4) More often under severe use such dusty area, sand, snow, wet or muddy conditions.

(5) After cleaning 6 times.

(6) replace only if necessary

Greasing points

■ Greasing points (fig. 1, 2, 3, 4, 5, 6, 7, 8, 9)

All models

- 6 nipples in axle articulation of chassis and connecting rod lean **(a)**
- 2 nipples in steering cylinder **(b)**
- 3 nipples in the universal joints, one in each cross and one in the fluted **(c)**
- 2 nipples, one on each typing cylinder, one on each hinge pin. **(d)**
- 1 nipple in each articulation of the bucket elevation system **(e)**
- 3 nipples in the turning crown **(f)**

D 250 AHGA

- 4 nipples (2 each side) in the high-tipping frame rear pins **(g)**.
- 4 nipples (2 each side) in the high-tipping frame front pins **(h)**.
- 4 nipples (1 each side) in the high-tipping system ram **(i)**.

See MAINTENANCE CHART AND LUBRICATION for the lubrication periods.
See FLUIDS AND LUBRICANTS for the type of grease to use .



(fig. 1)

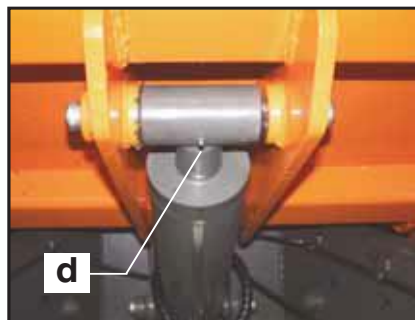

(fig. 4)

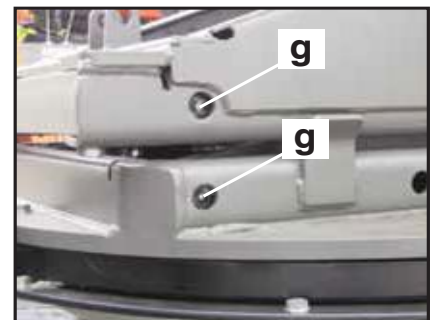

(fig. 7) AHGA

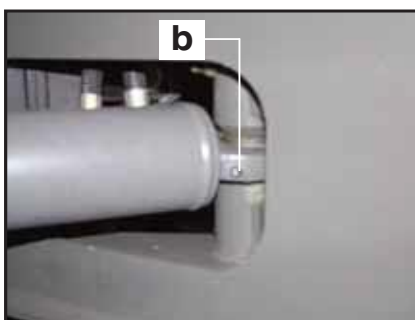

(fig. 2)

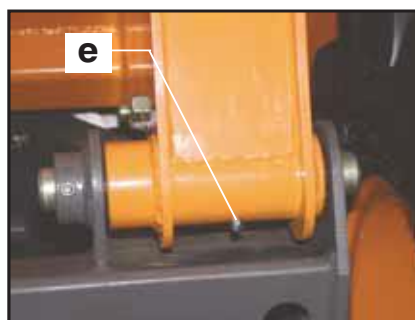

(fig. 5)

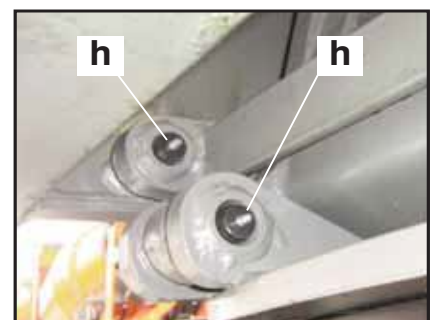

(fig. 8) AHGA



(fig. 3)



(fig. 6)

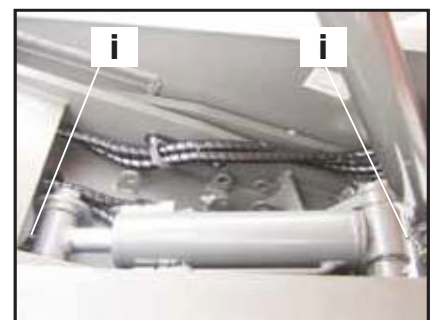

(fig. 9) AHGA



Electric diagram

CABLES COLOURS	
A	Light Blue
B	White
C	Orange
G	Yellow
H	Grey
L	Blue
M	Brown
N	Black
R	Red
S	Pink
V	Green
Z	Violet

Remark: In the bicolor cables, the longitudinal or traverse shape of the marks on the protective coating are to indicate the color. For example:

G-V: Yellow / Green with traverse marks

G/V : Yellow / Green with longitudinal marks



D 250 AHG / D 250 AHGA



Electric diagram

H1

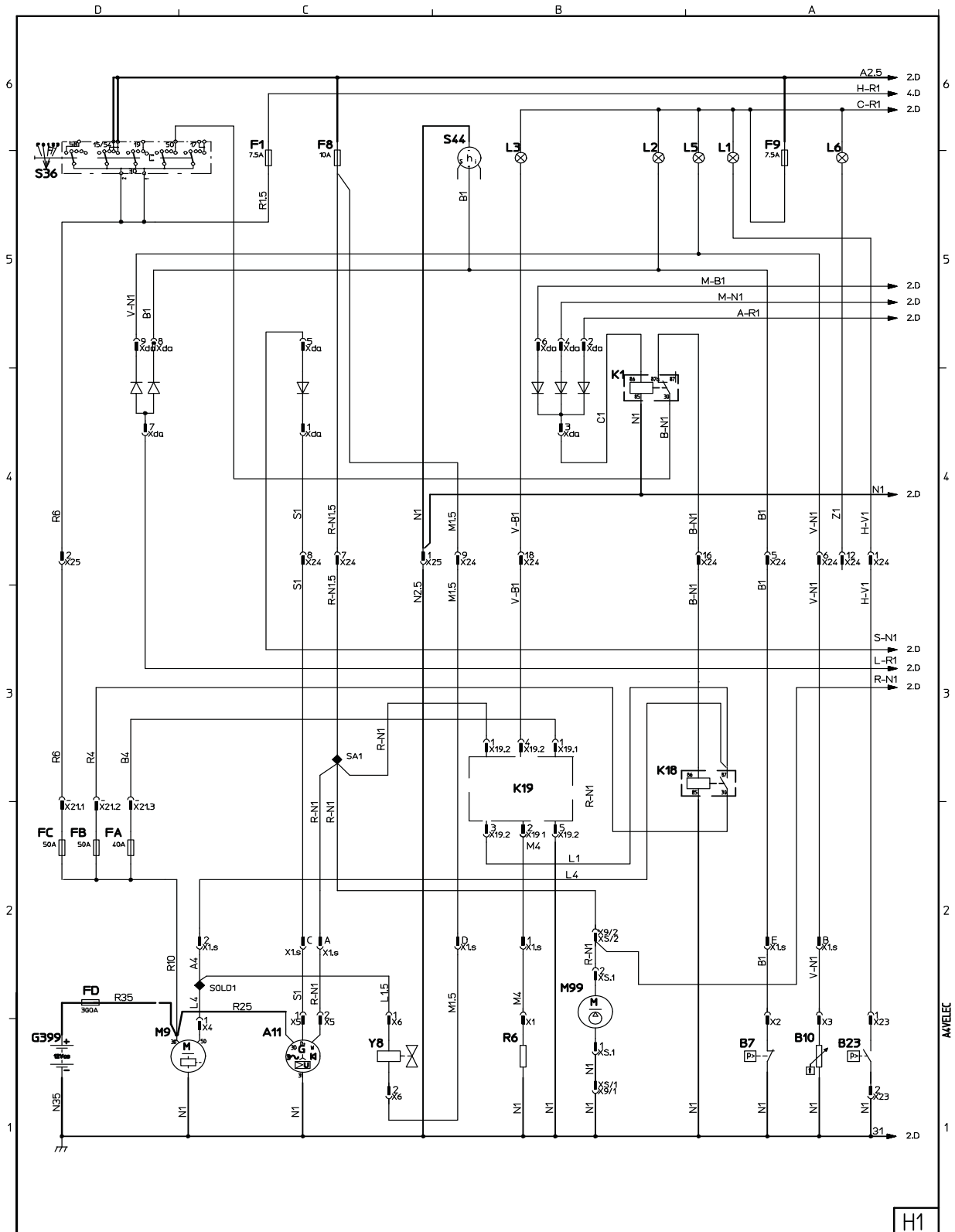



60



AUSA

D 250 AHG / D 250 AHGA

Electric diagram

H2

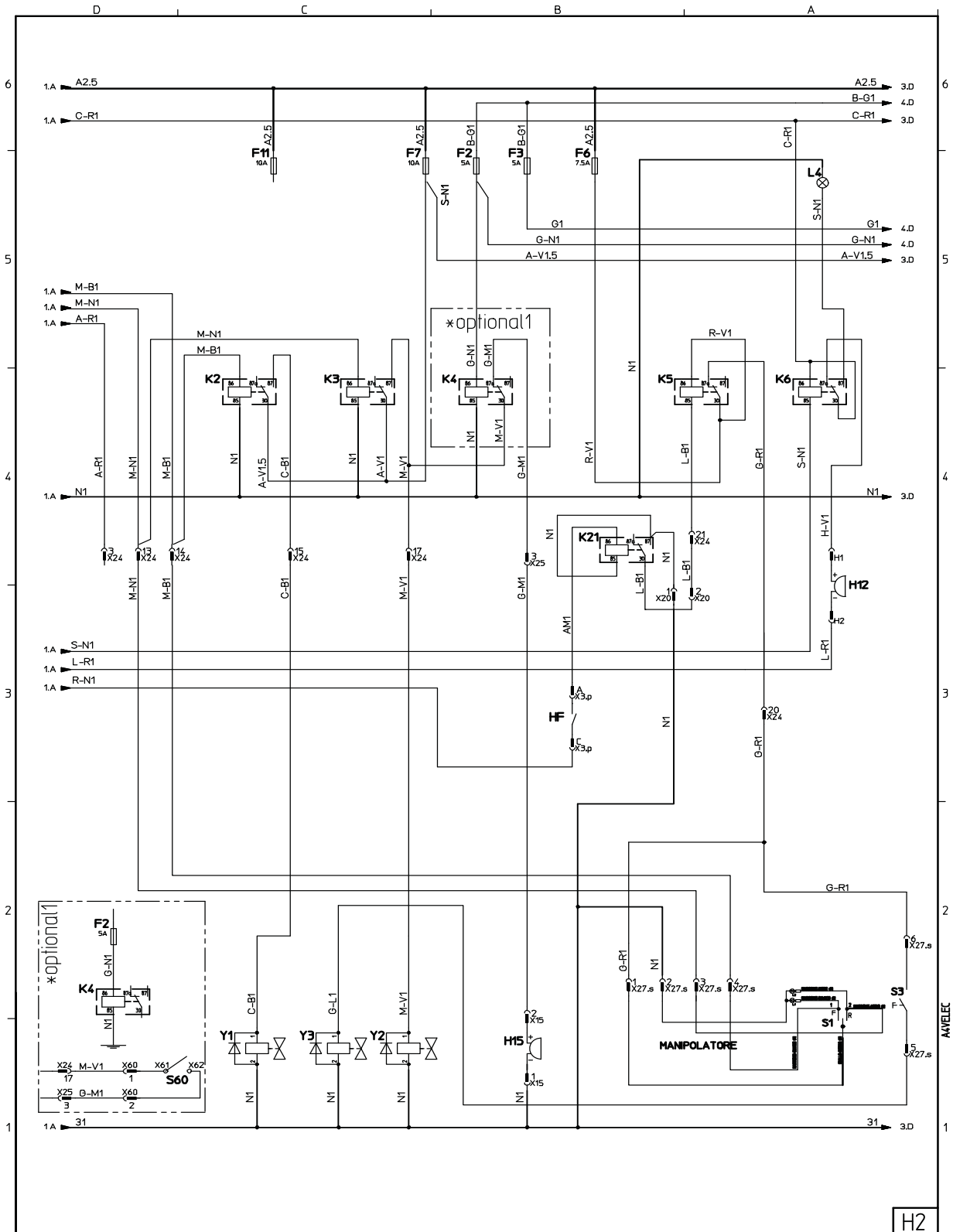



D 250 AHG / D 250 AHGA



Electric diagram

H3

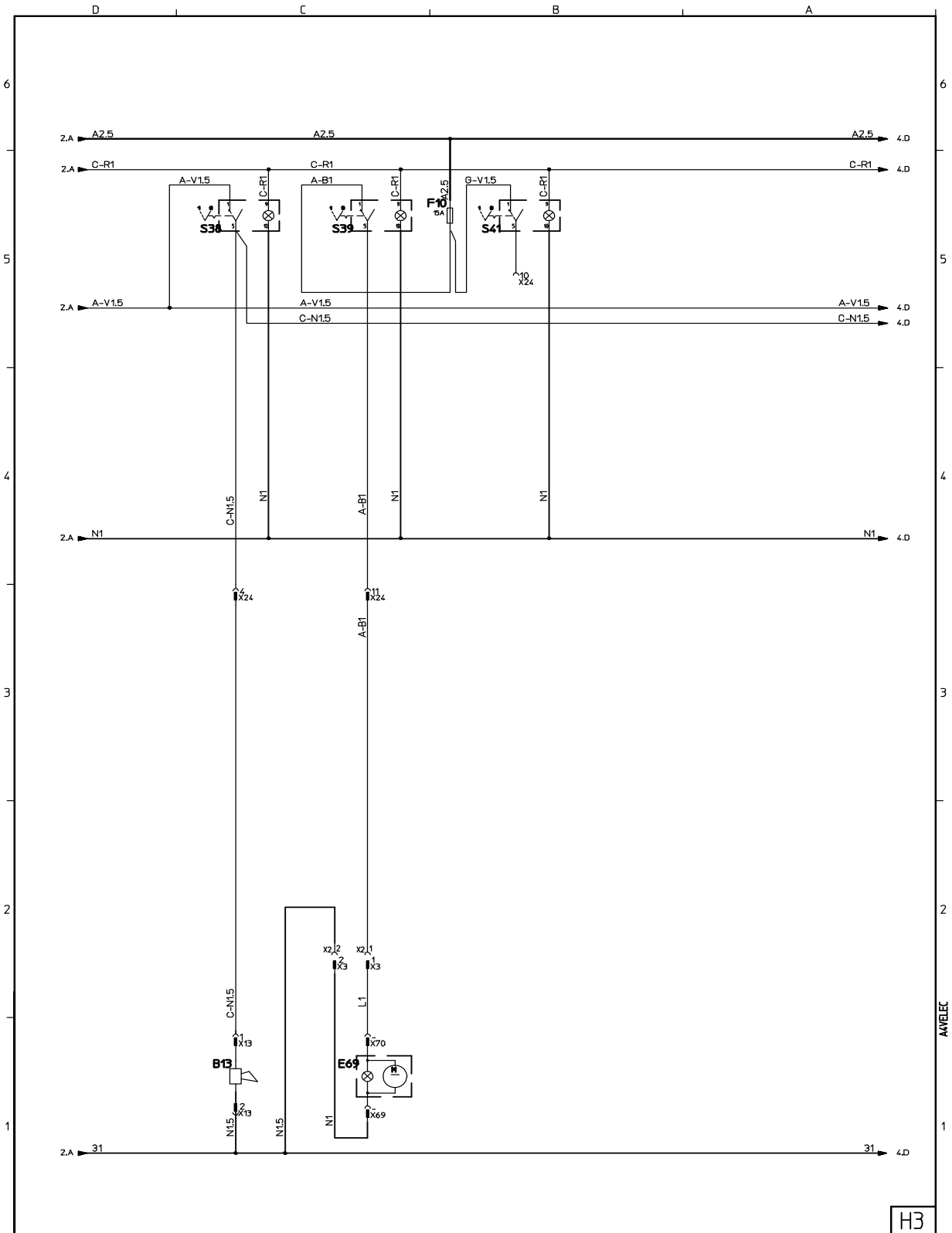



Electric diagram

H4

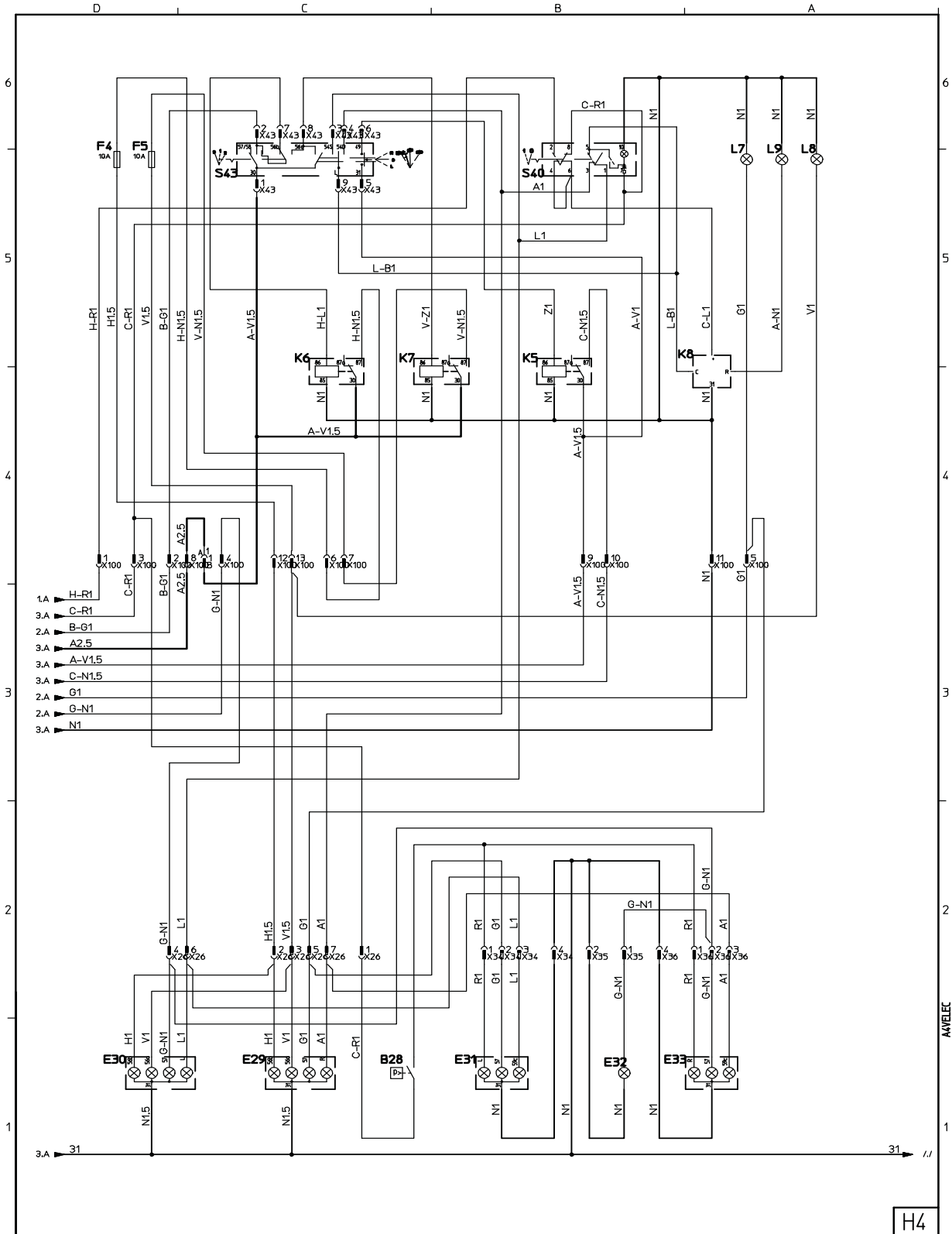



D 250 AHG / D 250 AHGA



Electric diagram

H5

Nombre/Item	Descripción	Description	Pg/Sh
A11	ALTERNADOR	ALTERNATOR	1
B7	PRESOSTATO PRESION MINIMA ACEITE MOTOR	ENGINE OIL MIN. PRESSURE SWITCH	1
B10	TERMOCONTACTO LIQUIDO REFRIGERANTE	COOLANT TEMPERATURE WARNING SWITCH	1
B19	BOCINA	HORN	3
B23	PRESOSTATO OBSTRUCCIÓN FILTRO AIRE	AIR FILTER BLOCKAGE INDICATOR	1
B28	PRESOSTATO LUCES DE FRENO	BRAKE LIGHTS PRESSURE SWITCH	4
E29	FARO DELANTERO DERECHO	RIGHT HEADLIGHT	4
E30	FARO DELANTERO IZQUIERDO	LEFT HEADLIGHT	4
E31	FARO TRASERO IZQUIERDO	REAR LEFT LIGHT	4
E32	LUZ PLACA MATRÍCULA	NUMBER PLATE LIGHT	4
E33	FARO TRASERO DERECHO	REAR RIGHT LIGHT	4
E69	FARO ROTATIVO	ROTATING BEACON	3
F1	FUSIBLE (4-30) LUCES DE EMERGENCIA (7,5A)	(4-30) WARNING FUSE (7,5A)	1
F2	FUSIBLE ZUMBADOR MARCHA ATRAS/LUCES POSICION IZQ (5A)	REVERSE SPEED BUZZER/LEFT POSITION LIGHT FUSE (5A)	2
F3	FUSIBLE LUCES DE POSICION (5A)	POSITION LIGHT FUSE (5A)	2
F4	FUSIBLE LUCES DE CRUCE (10A)	LOW BEAM FUSE (10A)	4
F5	FUSIBLE LUCES DE CARRETERA (10A)	HIGHT BEAM FUSE (10A)	4
F6	FUSIBLE (4-15) MANIPULADOR TOLVA (7,5A)	(4-15) JOYSTICK FUSE (7,5A)	2
F7	FUSIBLE (4-15) ELECTROVALVULAS ADELANTE/ ATRAS + CLAXON (10A)	(4-15) FRONT AND REVERSE SOLENOIDS + HORN FUSE (10A)	2
F8	FUSIBLE (4-15) ALTERNADOR/SOLENOIDE DE PARO MOTOR (10A)	(4-15) STARTER/ STOP ENGINE SOLENOID FUSE (10A)	1
F9	FUSIBLE (4-15) ILUMINACIÓN CUADRO DE INSTRUMENTOS (7,5A)	(4-15) WARNING LIGHTS FUSE (7,5A)	1
F10	FUSIBLE (4-15) FARO ROTATIVO (15A)	(4-15) ROTATING BEACON FUSE (15A)	3
F11	FUSIBLE (4-15) OPCIONAL (10A)	(4-15) OPTIONAL FUSE 10A	2
FA	MAXIFUSIBLE (4-15) ALM. CENTRALITA PRECALENTAMIENTO (40A)	(4-15) PREHEATER UNIT MAXIFUSE (40A)	1
FB	MAXIFUSIBLE (4-50) ALIMENTACIÓN RELÉ ARRANQUE (50A)	(4-50) STARTER MOTOR RELAY MAXIFUSE (50A)	1
FC	MAXIFUSIBLE (4-30) BATERÍA (50A)	(4-30) MAXIFUSE (50A)	1
FD	FUSIBLE MOTOR DE ARRANQUE (300A)	STARTER MOTOR FUSE (300A)	1
G399	BATERIA	BATTERY	1
H12	ZUMBADOR TABLIER	DASHBOARD BUZZER	2
H16	ZUMBADOR MARCHA ATRAS	REVERSE RELAY	2
HF	SENSOR FRENO DE ESTACIONAMIENTO	PARKING BRAKE SENSOR	2
K1	RELÉ PERMISO DE ARRANQUE	PERMISION START RELAY	1
K2	RELÉ MARCHA ADELANTE	FORWARD RELAY	2
K3	RELÉ MARCHA ATRAS	REVERSE RELAY	2
K4	RELÉ ZUMBADOR MARCHA ATRAS	REVERSE ALARM RELAY	2
K5	RELÉ FRENO DE ESTACIONAMIENTO	PARKING BRAKE RELAY	2
K5	RELÉ BOCINA	HORN RELAY	4
K6	RELÉ ZUMBADOR TABLIER	DASHBOARD BUZZER RELAY	2
K6	RELÉ LUCES DE CRUCE	LOW BEAM LIGHT RELAY	4
K7	RELÉ LUCES DE CARRETERA	HIGHT BEAM LIGHT RELAY	4
K8	RELÉ INTERMITENCIA	FLASHER RELAY	4
K10	RELÉ ARRANQUE	STARTER MOTOR RELAY	1
K19	RELÉ PRECALENTAMIENTO	PRE HEATING RELAY	1
K21	RELÉ FRENO ESTACIONAMIENTO	PARKING BRAKE RELAY	2
L1	INDICADOR OBSTRUCCIÓN FILTRO AIRE	AIR FILTER BLOCKAGE WARNING LIGHT	1
L2	INDICADOR PRESION ACEITE MOTOR	ENGINE OIL PRESSURE WARNING LIGHT	1
L3	INDICADOR PRECALENTAMIENTO	PREHEATING WARNING LIGHT	1
L4	INDICADOR CARGA BATERIA	BATTERY CHARGE WARNING LIGHT	2
L5	INDICADOR TEMPERATURA LIQUIDO REFRIGERANTE	COOLANT TEMPERATURE SWITCH WARNING LIGHT	1
L6	INDICADOR RESERVA	LOW FUEL LEVEL WARNING LIGHT	1
L7	INDICADOR LUCES DE POSICIÓN	POSITION LIGHTS WARNING LIGHT	4
L8	INDICADOR LUCES DE CARRETERA	HIGHT BEAM WARNING LIGHT	4
L9	INDICADOR LUCES DE DIRECCIÓN	FLASHER WARNING LIGHT	4
M9	MOTOR DE ARRANQUE	STARTER MOTOR	1
M99	BOMBA DE GASOL	FUEL PUMP	1
R6	RESISTENCIA PRECALENTAMIENTO MOTOR	ENGINE PRE HEATING RESISTANCE	1
S1	PALANCA DE MANDO	JOYSTICK	2
S38	INTERRUPTOR BOCINA	HORN SWITCH	3
S39	INTERRUPTOR FARO ROTATIVO	ROTATING BEACON SWITCH	3
S40	INTERRUPTOR LUCES DE EMERGENCIA	WARNING SWITCH	4
S41	INTERRUPTOR FARO DE TRABAJO	WORKING LIGHT SWITCH	3
S43	MANDO DE LUCES	STEERING COLUMN LIGHT SWITCH	4
S44	CUENTAHORAS	HOUR METER	1
S36	CONMUTADOR DE ARRANQUE	STARTING SWITCH	1
S60	INTERRUPTOR DESHABILITAR AVISADOR ACÚSTICO MARCHA ATRÁS (OPCIONAL 1)	DISABLE REAR GEAR BUZZER SWITCH (OPTIONAL 1)	2
SA?	SOLDADURA NÚMERO ?	SOLDER NUMBER ?	1/2
SOLD1	SOLDADURA 1	SOLDER 1	1
X??	CONECTOR NÚMERO ??	CONNECTOR NUMBER ??	1/2/3
Y1	ELECTROVALVULA MARCHA DE ADELANTE	FORWARD ELECTROVALVE	2
Y2	ELECTROVALVULA MARCHA ATRAS	REVERSE ELECTROVALVE	2
Y3	ELECTROVALVULA VELOCIDAD RÁPIDA	FAST SPEED SOLENOID	2
Y8	SOLENOIDE PARO MOTOR	ENGINE STOP SOLENOID	1

H5



Hydraulic diagram D 250 AHG

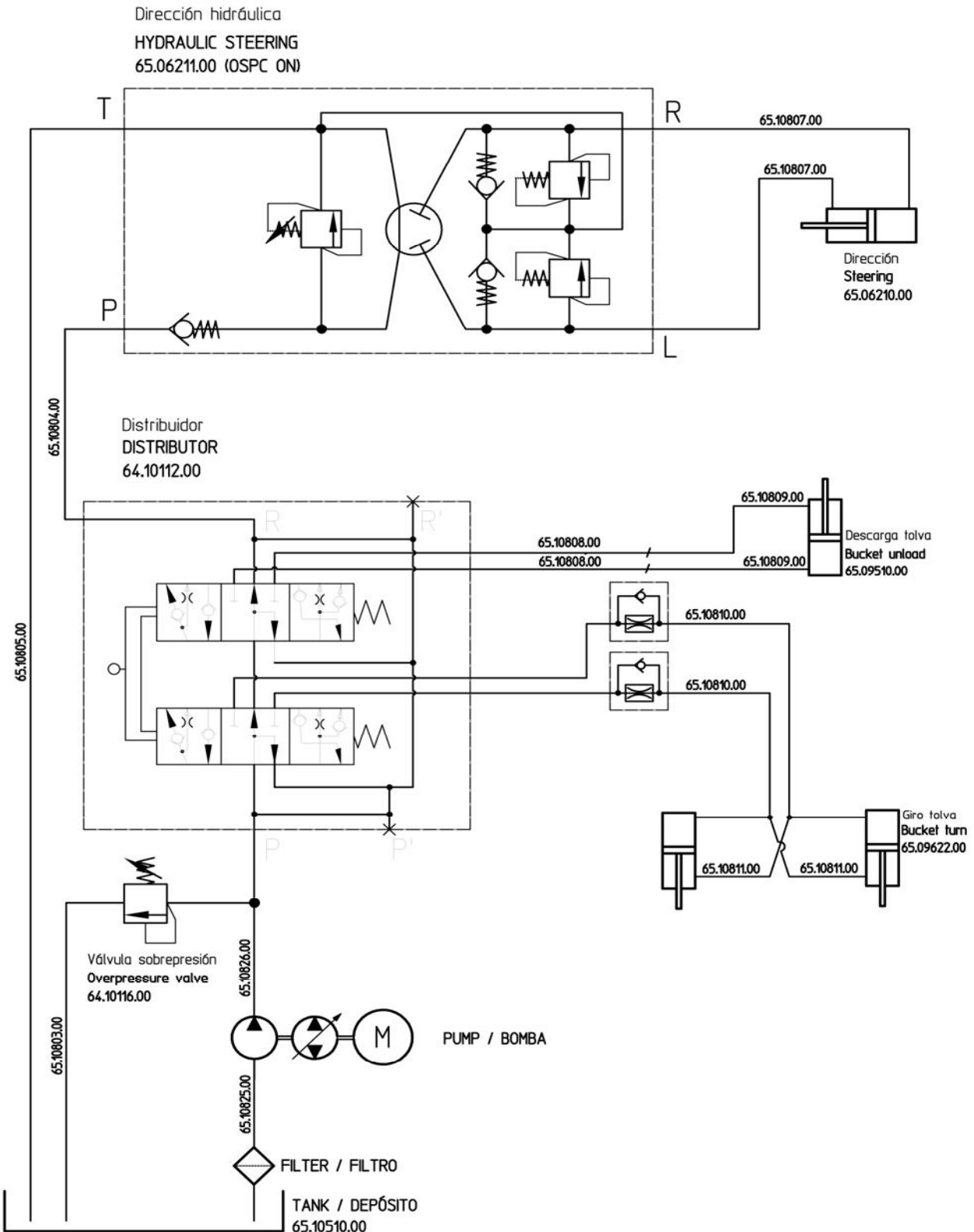

Hydraulic diagram D 250 AHGA

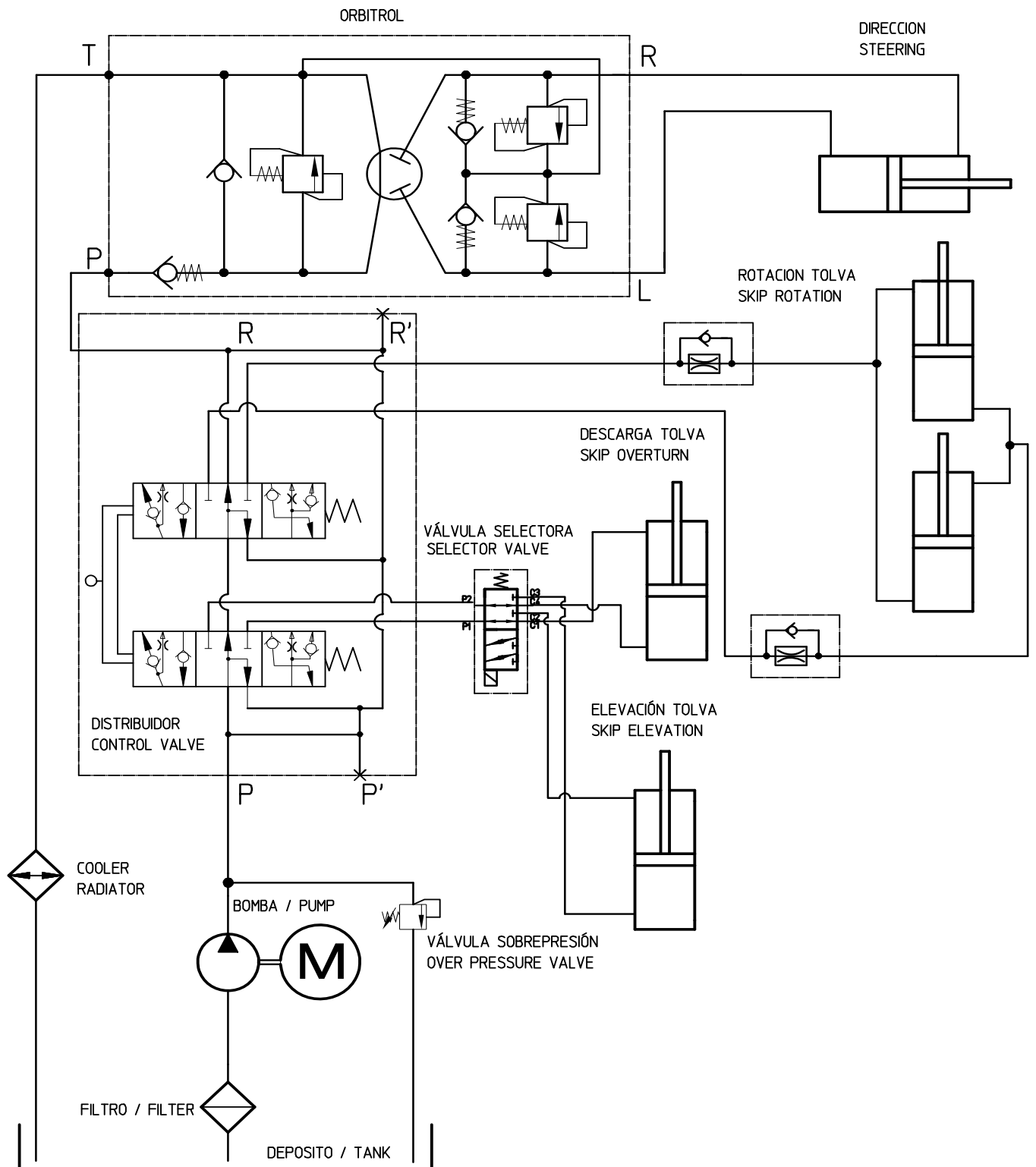



Hydraulic diagram transmission

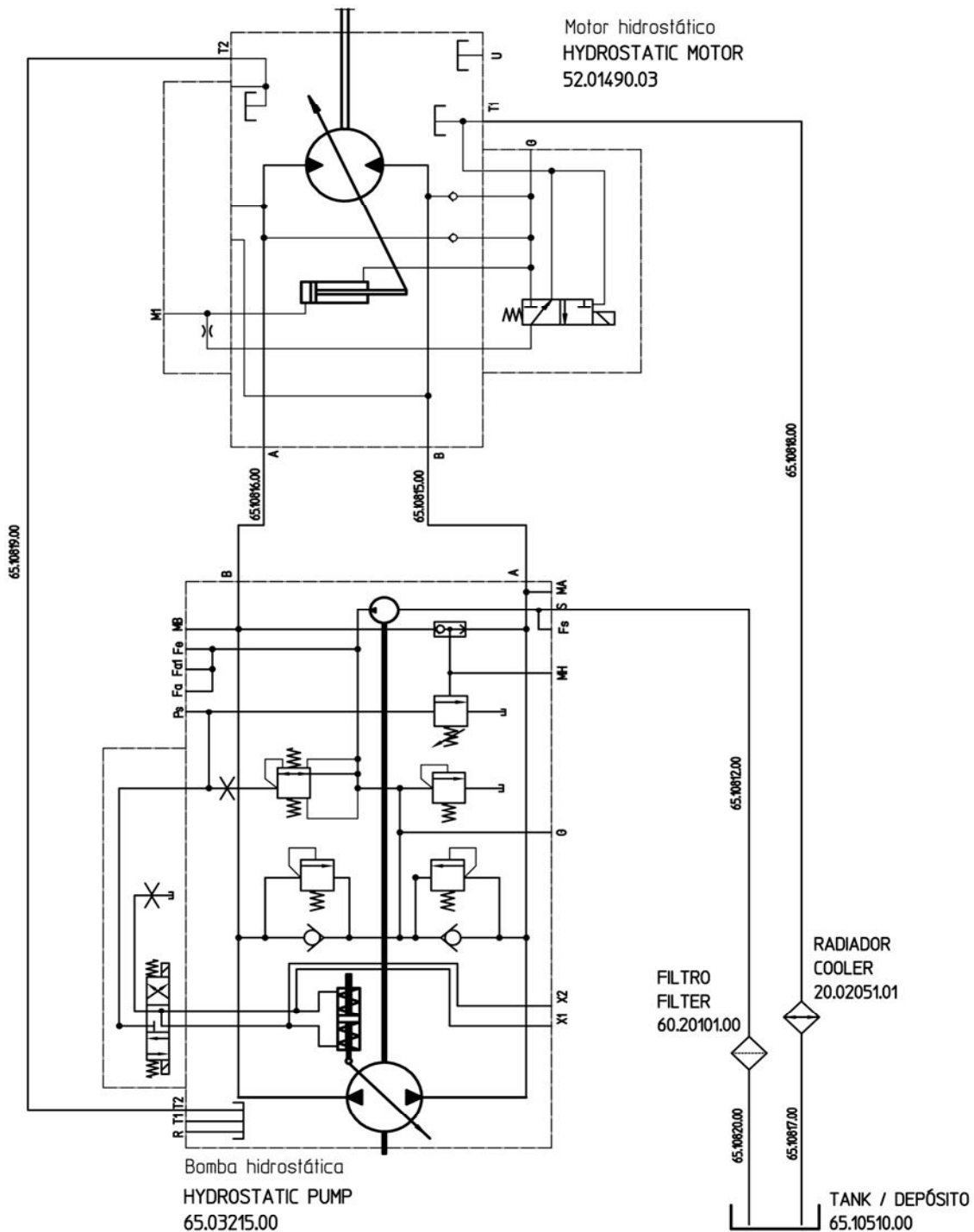



EC DECLARATION OF CONFORMITY

The manufacturer **AUSA Center, S.L.U.**, established on Ctra. de Vic, km 2.8, 08243 – Manresa – Barcelona – Spain, declares that the machine assigned below:

Generic denomination: **DUMPER**

Model/Type: **D 250 AHG**

Serial number: **XXXXXXXXXX**

fulfils all relevant provisions of the machinery Directive 2006/42/EC

and it conforms with the next European Directives:

Electromagnetic Compatibility Directive 2004/108/EC

Sound level Directives of machinery used outdoors, 2000/14/EC and 2005/88/EC

Exhaust emissions Directives, 97/68/EC and 2004/26/EC

and also it conforms with the following harmonized European Standards:

EN 474-1 – Earth-moving machinery – Safety – Part 1: General requirements.

EN 474-6 – Earth-moving machinery – Safety – Part 6: Requirements for dumpers.

The certification procedure has been carried out in accordance with the provisions relating to non-dangerous machinery in the above mentioned Directives.

Name and address of the person authorized to compile the technical file:

Mr

Ctra. De Vic, km 2.8, 08243, Manresa, Barcelona, Spain

Signed by Mr

Given at Manresa on / /



AUSA Center, S.L.U.
Cra. de Vic, Km. 2,8 - P.O.B. 194
08243 MANRESA (Barcelona) España

Tel. 34-93 87 47 311
Fax 34-93 874 12 11
Web: <http://www.ausa.com>



