



MANISCOPIC ■ MT 1840

PRIVILEGE





- Maximum lifting height: 17.50 m
- Capacity: 4000 kg
- Maximum forward reach: 13.17 m
- Torque convertor
- Hydraulic stabilizers
- Frame levelling: $\pm 9^\circ$



MT 1840

PRIVILEGE

 **Lifting capacity**4000 kg
at 500 mm from forks heels.
Tipping load at maximum reach :
with stabilizers950 kg
Tear out force with bucket
to ISO 83138000 daN

 **Lifting height**17.50 m
Times : unladen / loaded (in s)
Lifting (standard)17/17.1
Lifting (EP)12.1/12.2
Lowering.....14.5/14.3
Extension boom.....27.5/33
Retraction boom26.4/25.5
Crowd.....4.3
Dump.....4

 **Tyres**.....440/80-24

 **Forks** (mm)
Length1200
Width x thickness125 X 50
Maximum distance between forks1040
Carriage rotation126°

 **Multidisc brakes - hydraulically assisted on both axles**

 **PERKINS Engine**
Deutz TD 3.6 L
75 PK
Direct injection
Water cooling

 **Transmission**.....Torque convertor
Electro-hydraulic reversing shift
4 speeds forward and reverse
Maximum travel speed (km/h).....25

 **Hydraulics**
Pump.....gear type
Pressure/capacity270 bars/170 l/mn

 **Capacities**
Cooling system20 l.
Engine oil10.9 l.
Hydraulic oil.....135 l.
Transmission oil23 l.
Fuel tank.....140 l.

 **Weight unladen**11380 kg
Overall width2.40 m
Overall height2.50 m
Turning radius (outside wheels)3.99 m
Overall Length6.27 m
Ground clearance0.44 m
Drawbar pull10300 daN

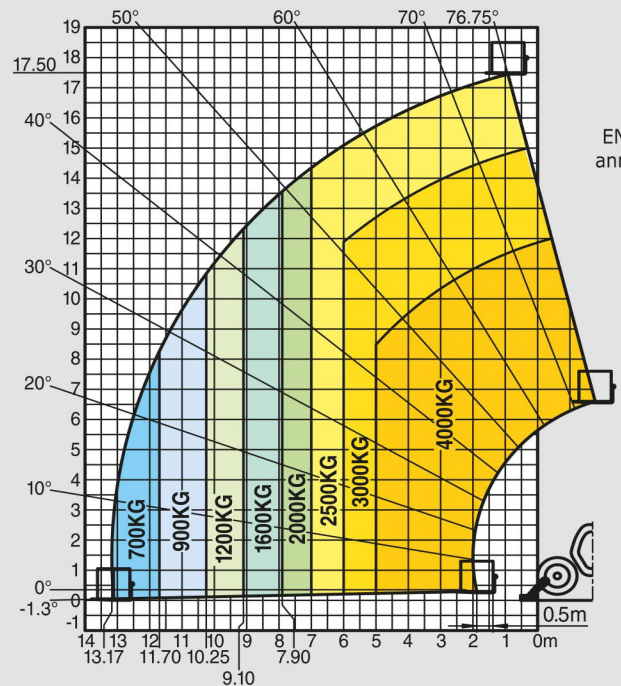

Under
EN 1459
annexe B

A	1200
B	3070
C	2044
C1	1929
D	6270
D1	6159
D2	4886
E	7473
F	1960
F1	1960
G	437
G1	420
G2	433
G3	302
H	9°
H1	9°
I	1160
J	892
K	1040
L	50
N	1908
O	125
P2	37°
P3	34°
R	3779
S	8780
T	4307
U1	2505
U2	2693
V	5592
V1	1285
V2	3998
22	2397
W1	3793
W2	1134
W3	2422
Y	12°
Z	114°

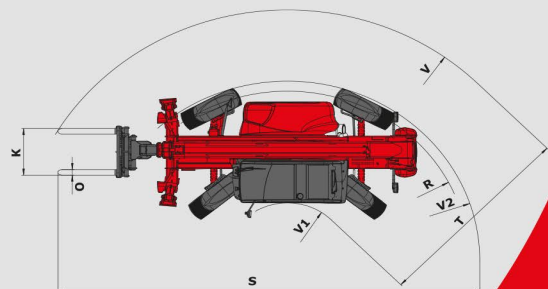
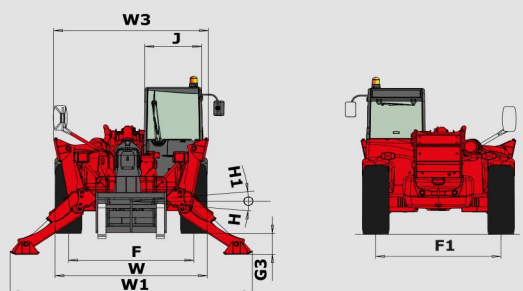
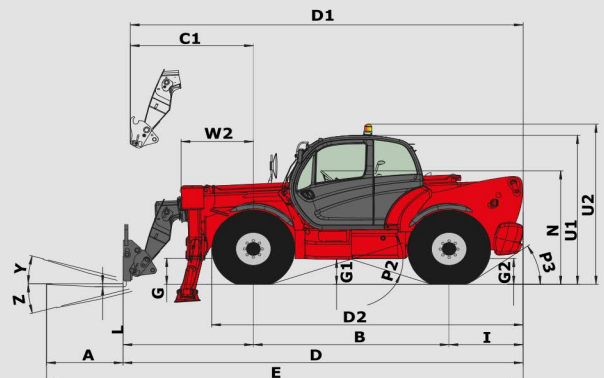

The specifications contained herein shall not bind the manufacturer and are subject to change without notice. This equipment described in this leaflet may be standard, optional, or unavailable, depending on the versions. For more details, contact your MANITOU dealer.

