



AE10200VDR4-01

Operation & Maintenance Manual

**FULL ROTATION TYPE
RUBBER CRAWLER CARRIER**

MST-200VDR

Serial No. 20R015 and up

⚠ WARNING

Unsafe use of this machine may cause serious injury or death. Operators and maintenance personnel must read this manual before operating or maintaining this machine. This manual should be kept near the machine for reference and periodically reviewed by all personnel who come into contact with it.

MOROOKA



CONTENTS

ITEM	Page
FOREWORD	0 - 1
1. Foreword	0 - 2
2. Introduction	0 - 3
3. Safety information	0 - 4
4. Location of serial number	0 - 5
SAFETY	1 - 1
1. General precautions	1 - 2
2. Precautions during inspections and maintenance	1 - 4
3. Precautions before starting engine	1 - 9
4. Precautions when starting engine	1 - 11
5. Precautions when traveling	1 - 12
6. Precautions for operation	1 - 15
7. Precautions for transportation	1 - 17
8. Position for attaching safety labels	1 - 18
OPERATION	2 - 1
1. General view	2 - 2
1.1 General view of the machine	2 - 2
1.2 General view of operator's compartment	2 - 3
2. Equipment	2 - 4
2.1 Control panel, meters on instrument panel, lamps	2 - 4
2.2 Switches on control panel	2 - 6
2.3 Safety lock lever	2 - 8
2.4 Travel levers	2 - 9
2.5 Dump control lever	2 - 11
2.6 Swing control lever	2 - 12
2.7 Dump body safety bar	2 - 12
2.8 Fuse box in electrical component cover	2 - 13
2.9 Fuses inside wiring harness	2 - 14
2.10 Operator's seat	2 - 15
2.11 Seat belt	2 - 16
2.12 Engine cover	2 - 17
2.13 Operator's seat side cover	2 - 17
2.14 Battery inspection cover	2 - 17
3. Operation	2 - 18
3.1 Check before starting engine	2 - 18
3.2 Operations and checks before starting engine	2 - 21
3.3 Starting engine	2 - 22
3.4 Moving machine	2 - 25
3.5 Shifting speed range and changing between forward and reverse	2 - 27



ITEM	Page
3.6 Steering machine	2 - 29
3.7 Stopping machine	2 - 33
3.8 Emergency stop	2 - 33
3.9 Swinging revolving upper structure	2 - 34
3.10 Parking	2 - 35
3.11 Stopping engine	2 - 35
3.12 Leaving operator's seat	2 - 36
3.13 Checks after stopping engine	2 - 36
3.14 Locking	2 - 36
3.15 Precautions when traveling	2 - 37
4. Handling dump body	2 - 38
4.1 Operating dump body	2 - 38
4.2 Operating safety bar	2 - 39
4.3 Precautions during operation	2 - 40
5. Handling rubber crawler	2 - 41
5.1 Features of rubber crawler	2 - 41
5.2 Prohibited operations for rubber crawler	2 - 41
5.3 Precautions when using rubber crawler	2 - 42
6. Transportation	2 - 43
6.1 Loading, unloading work	2 - 43
6.2 Precautions for loading	2 - 43
6.3 Precautions for transportation	2 - 43
7. Cold weather operation	2 - 44
7.1 Precautions for low temperature	2 - 44
7.2 After completion of work	2 - 45
7.3 After cold weather	2 - 45
8. Long-term storage	2 - 46
8.1 Precautions before storage	2 - 46
8.2 Precautions during storage	2 - 46
8.3 Precautions after storage	2 - 46
9. Handling battery	2 - 47
9.1 Precautions when handling battery	2 - 47
9.2 Removal and installation of battery	2 - 48
9.3 Precautions when charging battery	2 - 48
9.4 Starting engine with booster cables	2 - 49
10. Troubleshooting	2 - 50
10.1 Problems with engine related parts	2 - 50
10.2 Problems with chassis related parts	2 - 51
10.3 Problems with electric related parts	2 - 52



ITEM	Page
MAINTENANCE	3 - 1
1. Basic outline of maintenance	3 - 2
2. Precautions for maintenance	3 - 4
3. Use of fuel and lubricants according to ambient temperature	3 - 6
3.1 Fuel, coolant, and lubricant table	3 - 6
4. Tools and tightening torques	3 - 8
4.1 Supplied tools	3 - 8
4.2 Torque list for bolts and nuts	3 - 9
5. Periodic replacement of critical parts	3 - 10
5.1 Periodic replacement interval (every 2 years)	3 - 10
5.2 Periodic inspection	3 - 10
5.3 Specified periodic replacement parts	3 - 11
6. Maintenance schedule chart	3 - 12
7. Maintenance procedures	3 - 14
7.1 Outline of maintenance procedures	3 - 14
7.2 Initial 50 hour maintenance	3 - 14
7.3 Initial 100 hour maintenance	3 - 14
7.4 Initial 500 hour maintenance	3 - 14
7.5 Checks when required	3 - 15
7.6 Checks before starting	3 - 21
7.7 Every 50 hour maintenance	3 - 25
7.8 Every 100 hour maintenance	3 - 26
7.9 Every 200 hour maintenance	3 - 29
7.10 Every 250 hour maintenance	3 - 31
7.11 Every 450 hour maintenance	3 - 32
7.12 Every 500 hour maintenance	3 - 34
7.13 Every 800 hour maintenance	3 - 36
7.14 Every 1500 hour maintenance	3 - 37
7.15 Every 3000 hour maintenance	3 - 37
SPECIFICATIONS	4 - 1
1. Dimension drawing	4 - 2
2. Specifications table	4 - 3





FOREWORD

1. Foreword	0 - 2
2. Introduction	0 - 3
3. Safety information	0 - 4
4. Location of serial number	0 - 5



1. FOREWORD

Thank you for purchasing a Morooka Full Rotation Type Rubber Crawler Carrier. This manual describes procedures for operation, handling, testing, and maintenance required for extended use of our rubber crawler carrier. Please read this manual carefully BEFORE operating the machine to ensure optimal performance of the machine. Please make sure that you read the separate engine operation manual for details on how to operate the engine.

WARNING

Improper operation and maintenance of the machine can be hazardous and could result in serious injury or death. Operators and maintenance personnel should read this manual thoroughly before beginning operation or maintenance.

Always keep this manual on the machine and be sure to read and understand it thoroughly before performing operation and maintenance.

Some actions involved in operation and maintenance of the machine can cause a serious accident if they are not done in the manner described in this manual.

- **Do not operate the machine unless you are sure that you thoroughly understand the explanations and procedures written in this manual.**
- **Keep this manual available at all times and have all personnel read it periodically.**
- **If this manual has been lost or has become dirty and cannot be read, request a replacement manual from Morooka or your Morooka distributor.**
- **If you lend the machine to another person, always have that person read the operation manual and make sure that they thoroughly understand the contents of the manual before starting operation.**
Especially, ensure that they follow the safety regulations when operating.
- **Continuing improvements in the design of the machine can lead to changes in detail which may not be reflected in this manual.**
Consult Morooka or your Morooka distributor for the latest available information of your machine or for questions regarding information in this manual.
- **The description about safety is given in SAFETY INFORMATION on page 0-4 and in SAFETY from page 1-1.**



2. INTRODUCTION

1. FEATURES OF THE MACHINE

- Low-ground-pressure rubber crawler carrier that can travel easily on uneven ground, soft ground, or snow.
- Long, wide rubber crawler to provide powerful and stable drawbar pull.
- Hydraulic drive to allow travel operations to be carried out with the 2 levers to give forward and reverse with stepless speed change, as well as turning and stopping.
- As the revolving upper structure swings 360°, forward and reverse travel can be done without making a U-turn, work efficiency in smaller spaces is improved.

2. BREAKING IN THE MACHINE

Your Morooka machine has been thoroughly adjusted and tested before shipment.

However, operating the machine under severe conditions at the beginning can adversely affect the performance and shorten the life of the machine.

Ensure proper break-in of the machine for the initial 100 hours (as indicated by the hour meter.) Proper break in will allow the machine to give you many years of service. During break in, pay particular attention to the following points.

- After starting the engine, let it idle for 5 minutes to carry out the warming-up operation.
- Avoid operation with heavy loads or at high speeds.
- Avoid sudden starts, sudden acceleration, sudden steering and sudden stops except in cases of emergency.

3. WARRANTY

If any failure that is considered to be the responsibility of Morooka should occur within 6 months of delivery of the new machine or within 600 hours on the hour meter, whichever comes first, repairs will be carried out free of charge in accordance with the warranty.



3. SAFETY INFORMATION

Most accidents are caused by the failure to follow fundamental safety rules for the operation and maintenance of machines.

To avoid accidents, read, understand and follow all precautions and warnings in this manual and on the machine before performing operation and maintenance.

Do not operate or carry out maintenance of the machine unless you are sure that you thoroughly understand the explanations and procedures.

To identify safety messages in this manual and on machine labels, the following signal words are used.

 **DANGER**

This word is used on safety messages and safety labels where there is a high probability of serious injury or death if the hazard is not avoided. Failure to avoid this hazard may also result in serious damage to the machine.

These safety messages or labels usually describe precautions that must be taken to avoid the hazard.

 **WARNING**

This word is used on safety messages and safety labels where there is a potentially dangerous situation which could result in serious injury or death if the hazard is not avoided. Failure to avoid this hazard may also result in serious damage to the machine.

These safety messages or labels usually describe precautions that must be taken to avoid the hazard.

 **CAUTION**

This word is used on safety messages and safety labels for hazards which could result in minor or moderate injury if the hazard is not avoided. This word might also be word for hazards where the only result could be damage to the machine.

NOTICE

This word is used for precautions that must be taken to avoid actions which could shorten the life of the machine.

Safety precautions are described in SAFETY from page 1-1.

Morooka cannot predict every circumstance that might involve a potential hazard in operation and maintenance.

Therefore the safety messages in this manual and on the machine may not include all possible safety precautions.

If any procedures or actions not specifically recommended or allowed in this manual are used, it is your responsibility to be sure that you and others can do such procedures and actions safely and without damaging the machine.

Under any circumstances, however, never perform work and operations that are prohibited in this manual. If you are unsure about the safety of some procedures, contact your Morooka distributor.



4. LOCATION OF SERIAL NUMBER

On this machine, a plate stamped with the machine serial number is affixed on the side of the cover at the forward right in the operator's compartment as shown in the right diagram.

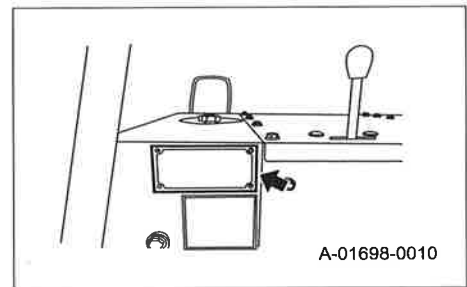

When inquiring about service or ordering parts, please quote the machine serial number, engine serial number, and hour-meter reading.





SAFETY

1. General precautions	1 - 2
2. Precautions during inspections and maintenance	1 - 4
3. Precautions before starting engine	1 - 9
4. Precautions when starting engine	1 - 11
5. Precautions when traveling	1 - 12
6. Precautions for operation	1 - 15
7. Precautions for transportation	1 - 17
8. Position for attaching safety labels	1 - 18

 **WARNING**

**Read and follow all safety precautions.
Failure to do so may result in serious injury or death.**



1. GENERAL PRECAUTIONS

SAFETY RULES

- Only trained and qualified personnel, or personnel authorized by the company (or superior) can operate and maintain the machine.
- Follow all safety rules, prohibitions, precautions, procedures, and instructions when operating or performing maintenance on the machine, and pay careful attention to safety.
- Operating the machine when you are not in good physical condition reduces the power of judgment needed to avoid danger and leads to accidents.
People in the following conditions should not operate the machine.
 - People who cannot operate normally because they are tired, ill, or suffering from the effects of medication
 - People who have been drinking
 - Pregnant women



XMA00030

SAFETY FEATURES

- Be sure that all guards and covers are in their proper position. Have guards and covers repaired if damaged.
- Use safety features such as safety lock levers properly.
Improper use of safety features could result in serious injury or death.
 - ★ Swing lock switch: See "2.2 SWITCHES ON CONTROL PANEL in OPERATION".
 - ★ Safety lock lever: See "2.3 SAFETY LOCK LEVER in OPERATION".
 - ★ Seat belt: See "2.11 SEAT BELT in OPERATION".

WEAR SUITABLE CLOTHING

- Always wear properly fitting clothes which allow ease of movement. If there are buttons, always button the cuffs.
- Avoid loose clothing, towels, jewelry, and loose long hair. They can catch on controls or in moving parts and cause serious injury or death.
- Also, do not wear oily clothes as they can easily catch fire.
- Wear a hard hat, safety glasses, non-slip safety shoes, and gloves when operating or maintaining the machine.

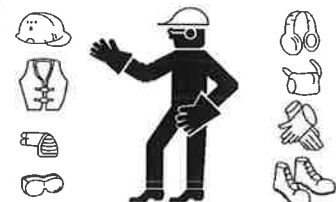

A0055010

FIRE EXTINGUISHER AND FIRST AID KIT

- Have fire extinguishers ready to use in case of fire and read the labels to ensure that you know how to use them.
- Provide a first aid kit at the storage point.
- Be sure that you know the phone numbers of persons you should contact in case of an emergency.



A0055070

MODIFICATION BY CUSTOMER IS PROHIBITED

Machine modification may void the warranty and/or affect machine performance and safety.



FIRE PREVENTION FOR FUEL, OIL, AND ANTIFREEZE

Fuel, oil, and antifreeze can be ignited by a flame. Fuel is particularly flammable and can be hazardous.

- Use well-ventilated areas for adding or storing oil and fuel.
- Keep oil and fuel in the place specified and do not allow unauthorized persons to enter.
- Tighten all fuel and oil caps securely.
- Keep any flame away from flammable fluids. Do not leave any cloths or rags soaked in oil or fuel lying in the fuel or oil storage area. Clean such materials up immediately.
- Do not bring any flame such as a lit cigarette or cigarette lighter close to flammable items.



A0055020



A0055030



A0055040

USE HANDRAILS TO GET ON OR OFF

Get on or off the machine as follows.

- Never jump on or off the machine. In particular, never get on or off a moving machine.
- When getting on or off the machine, always face the machine and use the handrails.
- If there is any oil, grease, or mud on the handrails, wipe it off immediately. Always keep these parts clean.



A-01698-0020



2. PRECAUTIONS DURING INSPECTIONS AND MAINTENANCE

NO UNAUTHORIZED PERSONS

Never allow unauthorized persons into the area when carrying out inspections and maintenance.

When leaving the operator's seat to carry out inspections and maintenance, hang a "DO NOT OPERATE!" sign (Part No.: 1-41010-1210) on the control lever to prevent any other person from operating the machine.

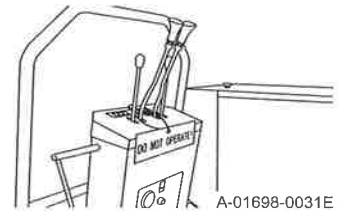

A-01698-0031E

USE SUITABLE TOOLS

Always use tools that are designed for the purpose. Do not use broken or deteriorated tools, or tools that are designed for other purposes.



A0055120

STOP ENGINE FOR INSPECTIONS AND MAINTENANCE

When carrying out inspections and maintenance, always follow the precautions below.

- Select firm, level ground to park the machine.
- Lower the dump body and stop the engine.
- Set the swing lock switch to the LOCK position.
- Ensure that each control lever is in the N (neutral) position. Pull the safety lock lever to the LOCK position.
- If the engine must be started to carry out inspection or maintenance, take steps to ensure that the engine can be stopped at any moment.
- When carrying out the operation with 2 or more workers, determine the order of operation and establish signals, and follow the instructions of the person in charge.

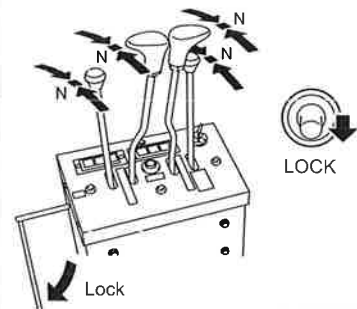

A-01698-0040E

ALWAYS KEEP MACHINE CLEAN

Always do the following to keep the machine clean.

- Always keep the floor, steps, and handrails free of oil, grease, mud, or water. There is a danger that you may slip and be injured. Wipe off any oil, grease, mud, water, or snow immediately.
- Do not leave tools or parts lying around on the floor or steps. There is a danger that you may trip over them. Clear up tools and parts immediately.
- Dry wood chips, leaves, grass, paper, oil, and other flammable items around the engine, muffler, battery, or hydraulic tank may cause fire. Remove any flammable items and wipe off any oil immediately.
- Always remove any mud accumulated around the undercarriage. There is a danger that you may slip and fall when stepping onto the rubber crawler.

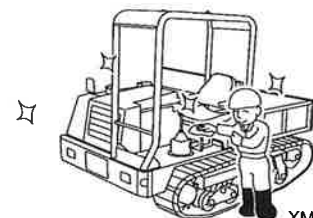

XMA19011



A0055020



VENTILATION FOR ENCLOSED AREAS

Exhaust fumes from the engine can be fatal.
If it is necessary to start the engine within an enclosed area, open the doors and windows to provide adequate ventilation.



A0055060

KEEP AWAY FROM ROTATING AND MOVING PARTS

- Do not go close to the fan when it is rotating.
Do not bring anything that can be caught up in the fan close to the fan.
- Do not come close to the dump body when it is moving.
There is a danger of getting caught or crushed.
- Do not go close to the rotating fly wheel (at the engine rear side). Do not bring anything that can be caught up.



A0055210

KEEP AWAY FROM FLAME WHEN ADDING FUEL

When filling the fuel tank with fuel, or when draining the water, always follow the precautions below.

- Stop the engine.
- Do not smoke or bring any flame close.
- After adding fuel, tighten the cap securely and wipe up any spilled fuel.
- Do not bend the fuel hose or hit it with any sharp object.
- If any hose is loose or damaged, always repair or replace it.



A0055020



A0055030



A0055040



DO NOT TOUCH HIGH-TEMPERATURE, HIGH-PRESSURE PARTS IMMEDIATELY AFTER STOPPING ENGINE

Immediately after stopping the engine, many parts are at high temperature or under high pressure.

If parts are removed or touched carelessly, there is a danger of burns or other injury.

For the following parts particularly, always wait for the machine to cool down before inspecting.

- Radiator and radiator cap
- Hydraulic tank and hydraulic hoses
- Oil Cooler
- Muffler and all parts of engine



A0055050

WAIT FOR ENGINE TO COOL BEFORE CHANGING ENGINE OIL

When changing the engine oil, always follow the precautions below.

- Stop the engine and wait for the engine and oil temperature to go down before changing the oil.
- After adding oil, tighten the cap and drain valve securely, then wipe up any spilled oil.

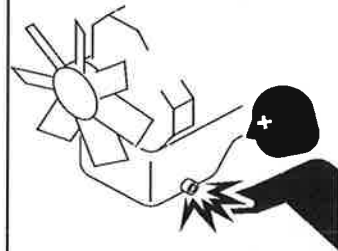

XMA00080

WAIT FOR WATER TEMPERATURE TO GO DOWN BEFORE ADDING COOLANT

Do not remove the radiator cap immediately after stopping the engine.

Always follow the precautions below.

- Stop the engine and wait for the water temperature to go down.
- Never attempt to fill coolant when the radiator cap is removed. Always fill coolant from the reserve tank.
- After adding water, tighten the cap securely and wipe up any spilled water.

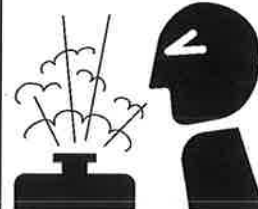

XMA05740

WAIT FOR PRESSURE TO GO DOWN BEFORE ADDING HYDRAULIC OIL

When adding oil to the hydraulic tank or when changing the oil, always follow the precautions below.

- Lower the dump body and stop the engine.
- Loosen the hydraulic tank cap slowly to release the internal pressure completely, then remove the cap.
- After adding oil, tighten the cap and drain plug securely and wipe up any spilled oil.

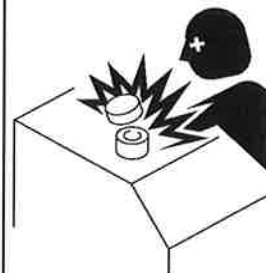

XMA00110



TAKE CARE WHEN HANDLING HIGH-PRESSURE HOSES

Remember that oil is always flowing under high pressure in the hydraulic hoses. Do not remove the hoses before the internal pressure has been released.

When handling the high-pressure hoses, always follow the precautions below.

- Do not bend the high-pressure hoses or hit them with any sharp object.
- If any hose is loose or damaged, always repair or replace it.
- It is extremely dangerous if oil is leaking from even small holes in the hoses or hydraulic equipment. If such a problem occurs, please contact your Morooka distributor.



A0055180

BE CAREFUL OF HIGH-PRESSURE GREASE WHEN ADJUSTING RUBBER CRAWLER TENSION

The tension adjuster for the rubber crawler is charged with grease. The grease is kept under high pressure by the recoil spring inside the tension adjuster.

Always follow the precautions below when adjusting the tension. If these precautions are not followed, the valve may fly out and cause serious injury.

- Never loosen the tension adjustment valve more than 1 turn. There is a danger that the valve may fly out.
- When adjusting the tension, never stand directly in front of the valve. It is dangerous.

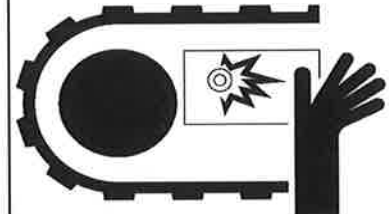

XMA00121

USE SAFETY BAR UNDER DUMP BODY

When going under the dump body to carry out operations, always follow the precautions below.

- Hang a "DO NOT OPERATE!" sign (Part No.: 1-41010-1210) in the operator's compartment to prevent anyone else from operating the machine.
- Always use the safety bar when going under the dump body.
 - ★ Safety bar: See "4.2 OPERATING SAFETY BAR" in OPERATION.

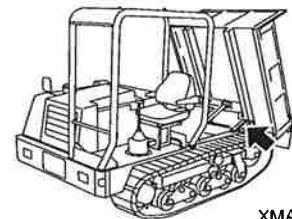

XMA19021



WHEN GOING UNDER THE REVOLVING UPPER STRUCTURE, ALWAYS SET SAFETY LOCK LEVER TO LOCK POSITION.

When going under the revolving upper structure to carry out operations, always follow the precautions below.

- Hang a "DO NOT OPERATE!" sign (Part No.: 1-41010-1210) in the operator's compartment to prevent anyone else from operating the machine.
 - Set the swing lock switch to the ON (LOCK) position.
 - Set the safety lock lever to the LOCK position to prevent the revolving upper structure from moving even if other person touches the swing control lever.
- ★ Safety lock lever: See "2.3 SAFETY LOCK LEVER in OPERATION".

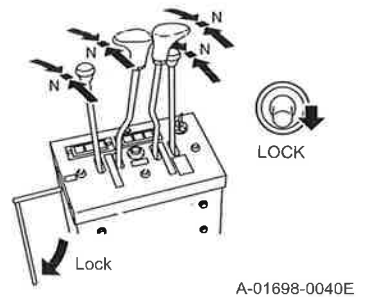
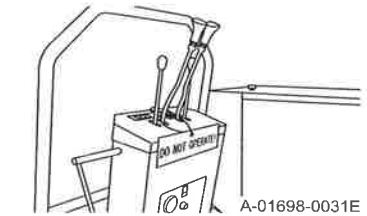

BE CAREFUL WHEN HANDLING BATTERY

- When checking or repairing the electrical system, always remove the negative (-) terminal from the battery to stop the flow of electricity. Failure to do so may cause burns or fire due to a short circuit.
- Be careful not to get battery electrolyte on your skin or clothes. If the battery electrolyte gets on you, wash it off immediately with water.



DO NOT SPRAY WATER ON ELECTRICAL COMPONENTS

When washing the machine, do not spray water on the electrical components.

If water gets into the electrical system, it may cause operational defects that lead to malfunctions.

Cover the following parts with a sheet to prevent water from getting on them.

- Instrument panel and control panel switches, sensors, connectors
- Starting motor, alternator, sensors, connectors around the engine
- Battery, relay, connectors at front right of the machine

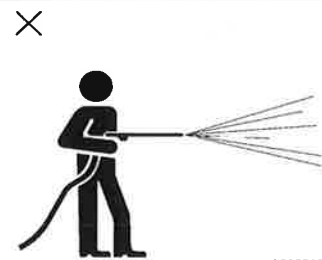

DISPOSE OF WASTE MATERIAL CORRECTLY

- When draining and changing the oil, always put a container under the engine and tank to catch the oil. Do not drain the oil directly into the ground or throw it into rivers or the sewage system.
- When disposing of oil, fuel, coolant, solvent, filters, batteries, and other harmful objects, always use a suitable method or procedure.

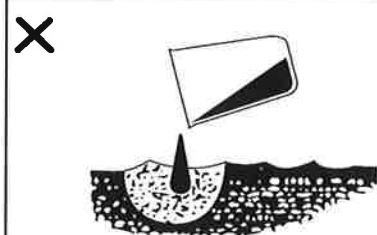

3. PRECAUTIONS BEFORE STARTING ENGINE

ALWAYS CARRY OUT CHECKS BEFORE STARTING

Before starting the engine, always carry out the walk-around checks and checks before starting given in this manual.

- Check the ground under the machine to see if there is any trace of oil or water leakage.
- In particular, check the undercarriage thoroughly for loose or missing nuts and bolts.
- If any abnormalities are found during checks before starting, carry out simple repairs. If the repairs are difficult, please contact your Morooka distributor.
The machine must not be used before repairs are carried out.

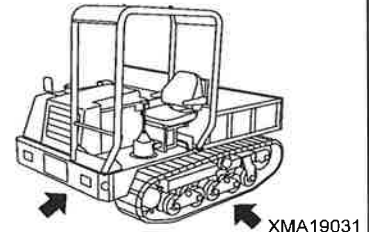

XMA19031

CHECK SAFETY PARTS AND LIGHTING

Check the operation of the following parts and devices needed for operation.

- Check that the horn, buzzer lights work normally.
- Check that the headlights light up normally.
- Check that the side mirrors are adjusted so that they give a clear view from the operator's seat.
- Clean the lights to ensure that they give good visibility.
- Adjust the operator's seat to a suitable position for operation. Always adjust the seat belt if it has been used by another operator.
- Check that the seat belt can be locked properly.
Always adjust the seat belt if it has been used by another operator.

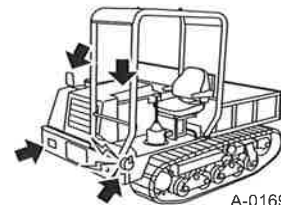

A-01698-0070

ALWAYS KEEP OPERATOR'S COMPARTMENT CLEAN

Always do the following to keep the operator's compartment clean and tidy.

- Always keep the floor, lever, and handrails free from oil, grease, mud, and water. Otherwise, there is a risk of human injury by slipping and falling. Wipe off any oil, grease, mud, water, or snow immediately.
- Do not leave tools or parts lying around on the floor or steps.
Keep these parts in the proper place to prevent them from obstructing operation.



XMA19011

FIRE PREVENTION

- Completely remove all wood chips, dead leaves, paper and other flammable items accumulated in the engine compartment. They could cause a fire.
- Check fuel, lubrication, and hydraulic systems for leaks.
Have any leaks repaired. Wipe up any excess oil, fuel or other flammable fluids.



A0055020



VENTILATION FOR ENCLOSED AREAS

Exhaust fumes from the engine can be fatal.

If it is necessary to start the engine within an enclosed area, open the doors and windows to provide adequate ventilation.



A0055060

SAFETY AT WORKSITE

Before starting operations, thoroughly check the area for any unusual conditions that could be dangerous.

- Check the terrain and condition of the ground at the worksite, and determine the best and safest method of operation. If there are any dangerous places, erect signs and take other steps to ensure safety.
- Check the depth and flow of water and the ground condition before operating in water or crossing a river. Never be in water which is in excess of the permissible water depth.
- If there are bridges or any other structure, check that they are of sufficient strength to support the weight of the machine.
- Do not allow any person other than the signalman to come close the worksite.
Restrict the entry even of related workers.

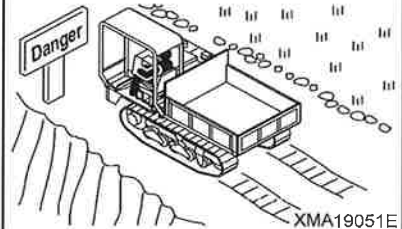



4. PRECAUTIONS WHEN STARTING ENGINE

PLACE LEVERS AT NEUTRAL

Always place the levers at the following positions.

- Set the travel lever at the N (neutral) position.
- Set the dump control lever and swing control lever at the HOLD position.
- Set the safety lock lever to the LOCK position.
- Set the swing lock switch to the LOCK position.
- Sit in the operator's seat and fasten the seat belt.

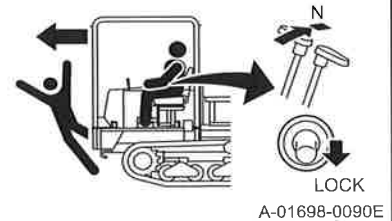

CHECK FOR SAFETY IN SURROUNDING AREA

Always check to make sure that there is no one in the surrounding area. In particular, make sure that there is no one under the machine.

- Never start the engine if a warning tag has been attached to the controls.
- When starting the engine, sound the horn to warn people in the area.
- Do not allow anyone other than the operator to ride on the machine.



5. PRECAUTIONS WHEN TRAVELING

IDENTIFY THE FRONT AND REAR OF THE REVOLVING UPPER STRUCTURE

Before riding on the machine, be sure to check that revolving upper structure (1) faces in the same direction (forward) as undercarriage structure (2).

The operating direction of the travel lever and pedal may need to be changed depending on the direction of the revolving upper structure.

- The figure on the right top shows the machine with revolving upper structure (1) and undercarriage structure (2) facing in the same direction.

Since sprocket (A) of undercarriage structure (2) is located rearward viewed from the operator's seat, the operating directions of the travel lever match the forward/reverse directions and turning directions (left turn and right turn) of the machine.

- The figure on the right bottom shows the machine with revolving upper structure (1) facing in the opposite direction (rear) of undercarriage structure (2).

Since sprocket (A) of undercarriage structure (2) is located forward viewed from the operator's seat, the operating directions of the travel lever are opposite to the forward/reverse directions and turning directions (left turn and right turn) of the machine.

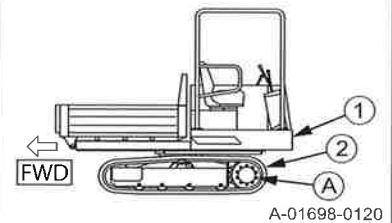
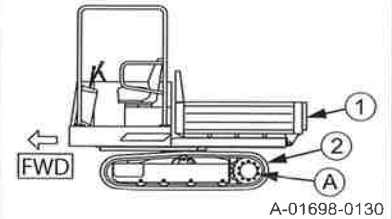

CHECK FOR SAFETY IN SURROUNDING AREA

Always ensure that there is no one in the surrounding area. In particular, make sure that there is no one behind the machine.

- If the dump body is raised, always lower it.
- Sound the horn to warn people in the area that you are about to start the machine.

AVOID SUDDEN OPERATIONS EXCEPT IN EMERGENCIES

Do not suddenly start, suddenly stop, or suddenly turn the machine or carry out any other operation suddenly. Such operations may cause the crawler to come off and the machine to tip over.

- When starting or turning the machine, operate the travel lever slowly.
Run the engine at low speed.
- Return the travel lever slowly to the N (neutral) position.
The brake is applied to stop the machine.
- If the travel lever is moved too far beyond the N (neutral) position to the REVERSE (or FORWARD) position, the engine will run in reverse, or other problems will occur.
- If a dangerous state occurs by any possibility, and when it becomes necessary to stop the machine urgently, turn the engine starting switch to the OFF position to stop the engine.

TRAVEL CAREFULLY ON UNEVEN GROUND OR ON CURVES

When traveling on uneven ground or in places where there are many curves, reduce the travel speed and travel carefully.

If the machine is traveling at high speed, it may turn over or crawler may come off.

NO TRAVELING ON PUBLIC ROADS

This machine is not permitted to travel on public roads.

When moving the machine, always transport it by truck or trailer.



BE CAREFUL OF ROAD SHOULDERS

When traveling on narrow agricultural roads, always follow the precautions below.

- Do not travel too close to the road shoulder, and travel at reduced speed.
- Do not travel on any soft road shoulder or place covered with grass.
- During or after rain, the danger of landslides and falling rocks increases. Always travel at low speed and check that the area is safe.

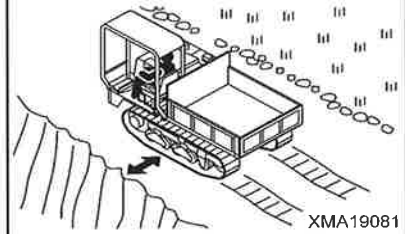

AVOID OBSTACLES

Avoid traveling over obstacles or earth embankments as far as possible. If the machine has to travel over an obstacle, do as follows.

Never travel over large boulders, breakable objects, pieces of concrete, or other sharp objects.

- Reduce the travel speed and travel carefully.
- Steer the machine so that the center of the rubber crawler passes directly over the obstacle. Mount the obstacle slowly, and when the machine goes over the top and starts to tip forward, stop the machine. Then slowly start the machine again. Never change direction when doing this.
- Earth embankments may collapse under the weight or vibration of the machine and cause the machine to slip, so drive the machine slowly and do not change speed or direction. Be particularly careful when traveling over freshly dug ditches. They may collapse.



TRAVELING ON SLOPES

When traveling on hills or slopes, always follow the precautions below.

- When traveling up or down on hills or slopes, select a place where the inclination angle is 9 degrees or below. If operating the machine on a large inclination angle is unavoidable, operate the machine only on a place where its maximum inclination angle is 15 degrees or less.
- Do not travel at an angle on a hill or slope, or parallel to the slope. Such action could result in the machine tipping over or slipping.
- When traveling up hills or slopes, always travel directly up the slope. Set the travel speed to a low range and keep the travel lever close to the N (neutral) position (low speed).
- Do not suddenly change speed on the slope. There is a danger that the direction of the machine may suddenly change and the machine may slip.
- When traveling down slopes, set the travel speed to a low range, run the engine at low idling, and operate the travel lever to a position less than 1/2 of the full stroke from the N (neutral) position. If the machine travels too fast, there is a danger that the engine may overrun, causing the machine to slip.
- When the slope caution buzzer on the operator's seat lights up, set the engine speed to a low speed, place the travel lever at a position close to N (neutral) position, and operate the machine carefully.
- Do not travel on grass, fallen leaves and branches, wet steel plates, or other slippery objects.
- If a dangerous state occurs by any possibility, and when it becomes necessary to stop the machine urgently, turn the engine starting switch to the OFF position to stop the engine.

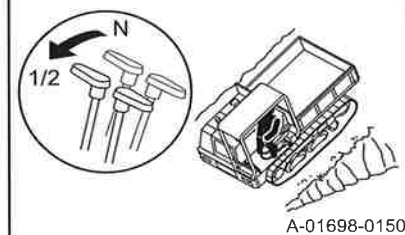
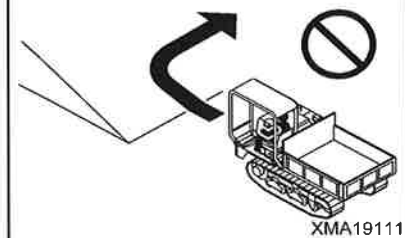
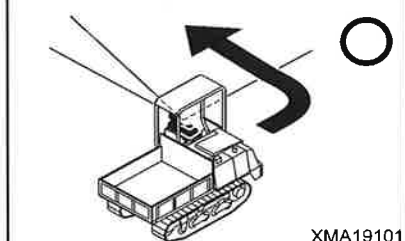



ENSURE GOOD VISIBILITY

When working in dark places or at night, turn on the headlights.
Also turn on the headlights when visibility is poor due to mist, snow, or rain.

OPERATE CAREFULLY ON SNOW

- When working on snow or icy ground, even a slight slope may cause the machine to slip to the side, so always travel at low speed and avoid sudden starting, stopping, or turning.
- When there has been heavy snow, holes and objects on the ground are buried in the snow and cannot be seen, so always carry out operations carefully.

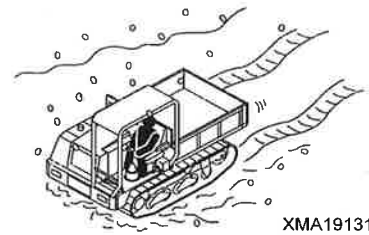

XMA19131

BEFORE SWINGING THE REVOLVING UPPER STRUCTURE, ENSURE THE SAFETY OF THE SURROUNDING.

- Always park the machine before swinging the revolving upper structure.
When swinging the machine from higher to lower direction on a slope, swing speed of the revolving upper structure increases due to gravity, causing unexpected accident.
- When there are persons or obstacles in the area around the machine, always position a signman and follow the signals to swing the revolving upper structure.
- Always operate the dump control lever slowly. Never attempt to swing the loaded revolving upper structure in high speed or rapidly stop swinging. Failure to do so may cause a failure and impair the safety in the surrounding area.

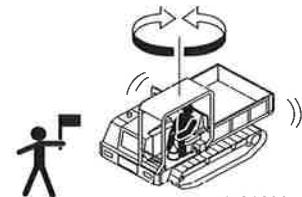

A-01698-2290

PARKING MACHINE

Park the machine on a firm, level ground.
Select a place where there is no problem of falling rocks, landslides, or floods.

If the machine has to be parked on a slope, do as follows.

- Stop the machine facing directly up or down the slope.
- Always put blocks under the rubber crawlers to prevent the machine from moving.
- Lower the dump body fully.

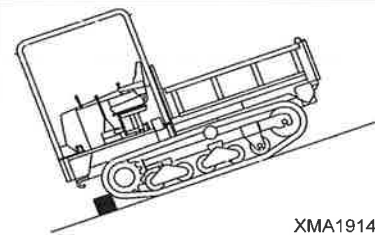

XMA19141

REMOVE KEY WHEN LEAVING MACHINE

When leaving the machine, always do as follows.

- Lower the dump body fully.
- Set the swing lock switch to the LOCK position.
- Place the travel lever at the N (neutral) position to stop the engine.
★ The parking brake will be automatically applied when the travel lever is placed at the N (neutral) position.
- Ensure that each control lever is in the N (neutral) position. Set the safety lock lever to the LOCK position.
- Remove the key from the engine starting switch and always take it with you.

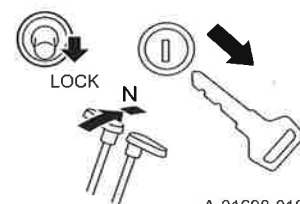

A-01698-0180E



6. PRECAUTIONS FOR OPERATION

USE SIGNALS

When carrying out work with one or more workers, or when using a signalman, determine the signals and the person in charge before starting work, and always follow the agreed procedure.

Even when using a signalman, always pay careful attention to the following.

- When working in confined spaces or indoors, be careful not to hit the surroundings or the ceiling.
- When operating in urban areas or on roads, put up fences around the worksite and take steps to ensure the safety of passing traffic and pedestrians.

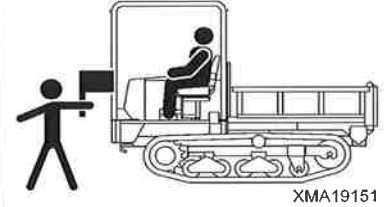

MAKE WORKSITE FLAT

Make the worksite flat. This not only increases the efficiency but also ensures safety. If the worksite is dusty, spray water to ensure the visibility.

OPERATE DUMP BODY CAREFULLY

When carrying out dumping operations, be careful of the following.

- Check that there is no person or obstacle near the dump body.
- Stop the machine at the determined point and operate the dump in accordance with signals from the signalman.
- Block the rubber crawlers to prevent the machine from moving in reverse.
- When dumping on slopes, there is a danger of the machine tipping over. If you feel that the machine is not stable, stop the operation immediately.

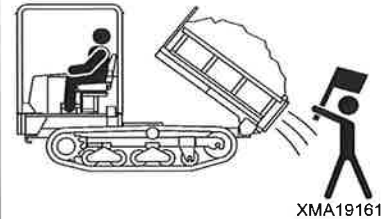

OPERATE DUMP BODY CAREFULLY AFTER SWINGING THE REVOLVING UPPER STRUCTURE

When carrying out dumping operations after swinging the revolving upper structure, take the following precautions other than those at normal dumping operation.

- When the revolving upper structure and undercarriage structure are facing in the opposite direction, the operating direction of the travel lever and pedal is opposite to forward/reverse direction of the machine. The operating direction of the travel lever may need to be changed depending on the direction of the upper revolving structure. Failure to do so can cause the machine to fall or hit other obstacles.
- When dump operation with the revolving upper structure swung 90 deg is unavoidable, check the condition of unloading place and secure sufficient distance between the machine, unloading place and the road shoulder beforehand. Swing the revolving upper structure after the machine is in the unloading position. After unloading, lower the dump body, swing the revolving upper structure to the original position, and then move the machine.
- Never attempt to carry out dump operation on a slope with the revolving upper structure swung 90 degrees. Failure to do so may cause the machine turn over. If you feel that the machine is not stable, stop the operation immediately.

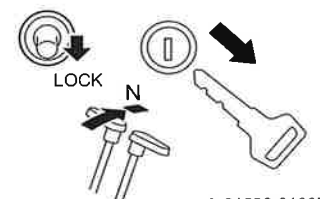
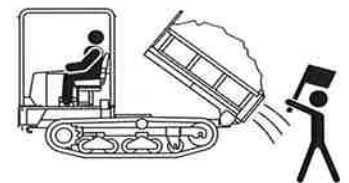
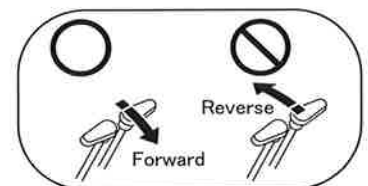



NO OVERLOADING

- Never load the machine above its capacity. Overloading not only causes failures, but also causes overrunning and tipping over on slopes.



XMA19171

LOAD DUMP BODY EVENLY

- Do not load the dump body on one side. Always spread the load to maintain the balance in the dump body.
- When carrying long objects, such as timber or steel beams, give careful consideration to the position of the center of gravity of the load, and secure with ropes.
- When loading stacks of U-shaped ditch liners or concrete blocks, lay a steel sheet and secure with rope, and take other steps to prevent the load from slipping.

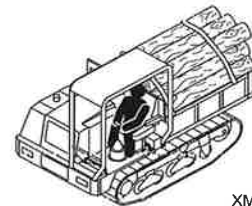

XMA19181

DO NOT GO CLOSE TO HIGH-VOLTAGE POWER LINE

When carrying out operations on worksites where there are transmission lines, use a signalman and take steps to protect the power lines. Check with the electricity company before starting operations.

- Going close to high-voltage power lines can cause electric shock, even if the machine does not touch the lines. Always maintain the safe distance given below between the machine and power lines.

	Voltage of Power Line	Minimum Safe Distance
Low voltage (Distribution line)	100 V, 200 V	2 m
	6600 V	2 m
Special voltage (Transmission line)	22000 V	3 m
	66600 V	4 m
	154000 V	5 m
	187000 V	6 m
	275000 V	7 m
	500000 V	11 m

- If the dump body should touch a power line, the operator should not leave the operator's compartment. He should call another worker to report the situation.

The following actions are effective in preventing accidents.

- Wear shoes with rubber soles and rubber gloves.
- Use a signalman to give warning if the machine approaches too close to the power lines.
Determine the signals to use in case of an emergency.
- Inquire with the electricity company about the voltage of power lines at the worksite.
- When carrying out operations near high-voltage lines, do not let anyone come close to the machine.

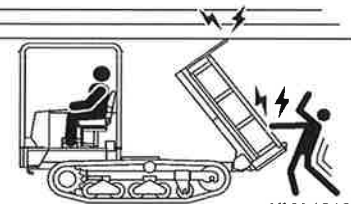

XMA19191



7. PRECAUTIONS FOR TRANSPORTATION

USE SAFE RAMPS

Always use ramps which fulfill the following conditions.

- Strong ramps which can fully support the weight of the machine.
- Ramps with a width greater than the width of the crawlers.
- Ramps of a length which does not form a steep angle when placed against the platform of the hauler to be used for transportation. Use ramps with an angle of 15 degrees or less. If the ramps are too long and they bend excessively, use blocks to support the ramps as necessary.
- Ramps with hooks and nonslip surface. If there is any slippery material on the ramps such as oil, mud or snow, wipe it off.

CORRECT

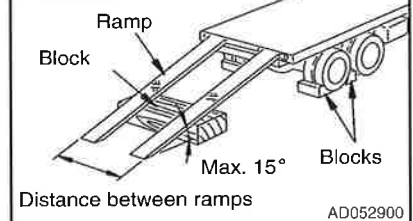

AD052900

LOADING AND UNLOADING

Loading and unloading the machine always involves potential hazards. **EXTREME CAUTION SHOULD BE USED.** Always do as follows:

- Perform loading and unloading on a firm level ground only.
- Stop the engine of the hauler, apply the parking brake securely, then block the tires.
- Set the ramps parallel and in line with the width of the crawlers.
- Secure the ramps to the dump body with the hooks.
- Set the machine to be loaded in line with the ramps, then approach the ramps at low speed.
- Do not change the direction of travel when on the ramps. If it is necessary to change the direction, drive the machine off the ramps, and set the machine to the correct direction.
- After loading, put blocks under the front and rear of the rubber crawlers to prevent the machine from moving, then tie the machine down with chains or wire rope.

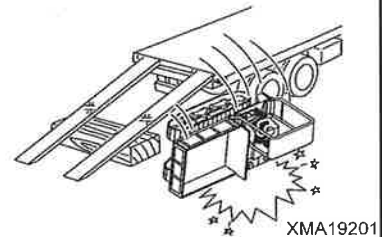

XMA19201

SHIPPING

- When shipping the machine on a hauling vehicle, obey all state and local laws governing the weight, width, and length of a load. Also obey all applicable traffic regulations.
- Take into account the width, height and weight of the load when determining the shipping route.

8. POSITION FOR ATTACHING SAFETY LABELS

Always keep these labels clean.

If they are lost or damaged, always attach them again or replace them with a new label.

There are other labels in addition to the safety labels listed below. Handle them in the same way.

The information on the safety labels shown in the diagram with numbers are provided at the end of this chapter.

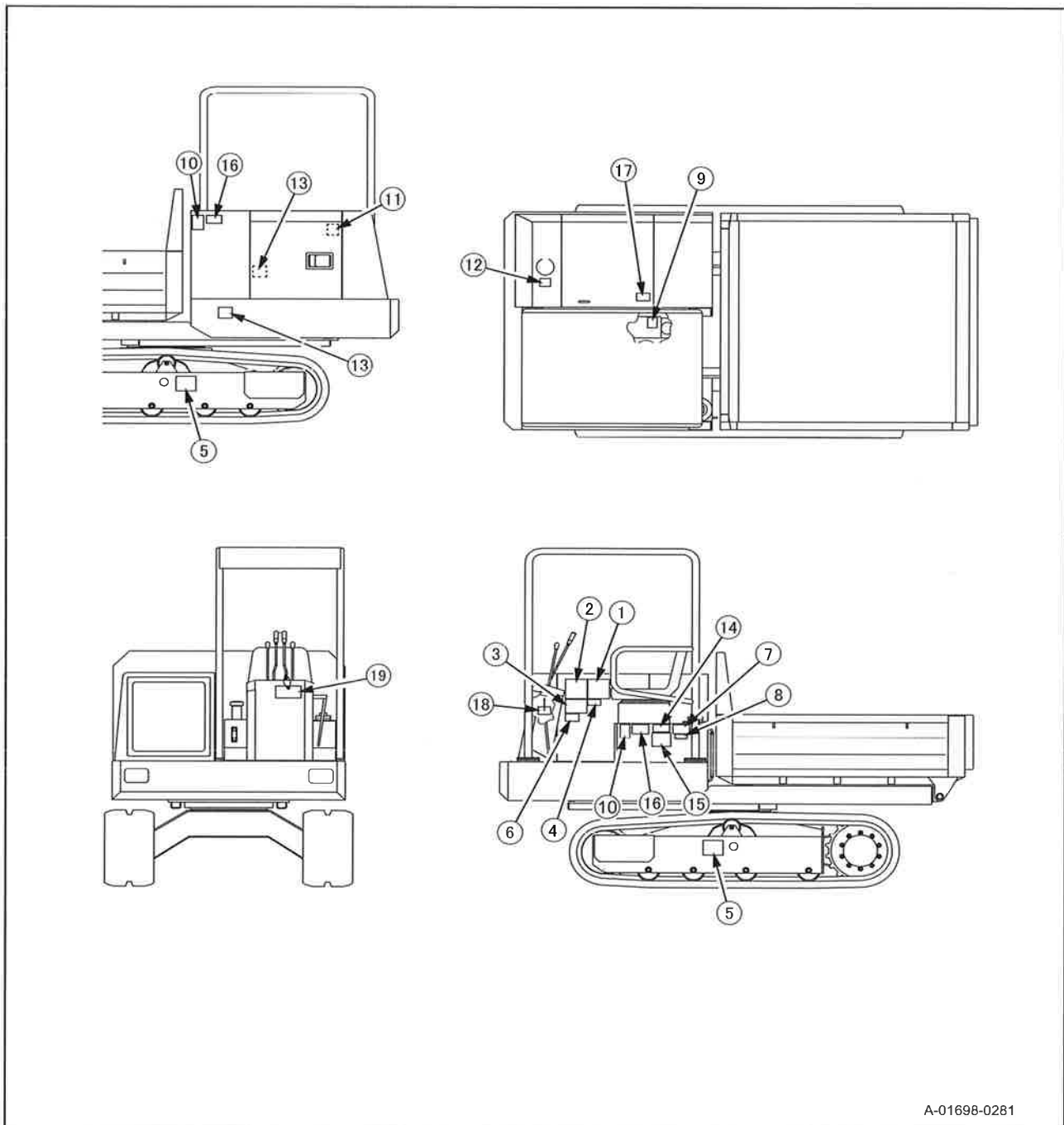

A-01698-0261



(1) Precautions when operation
(1-41010-1330)

⚠ WARNING
<ul style="list-style-type: none"> • Before operating the machine read the Operation & Maintenance Manual carefully. • Take extra care when traveling on uneven ground or oval-shaped ground. Depending on the track tension, this may cause the track to disengage or the machine to damage. • Always check if there are stones clogged around the inks before starting. • When entering under the dump body for checking, always use the safety bar to prevent the dump body lowering. • Always dump the load on the level, hard ground. • When leaving the operators seat, put the travel lever in the N position, and put the parking brake or the switch in the STOP position. • DO NOT use the parking brake as the service brake except in an emergency. • When leaving the machine, always take the key.
<small>1-41010-1330</small>

(2) Precautions when traveling downhill
(1-41010-1290)

⚠ WARNING
WHEN TRAVELLING DOWN SLOPES
<ul style="list-style-type: none"> • When traveling down slopes, reduce the engine speed before traveling on slopes, adjust the travel level throttle, and travel down the slope at low speed. • DO NOT travel across or parallel slopes. The machine may overturn sideslips. • NEVER travel down slopes at engine speed more than the rated engine speed. This may overturn and dangerous slipping.
<small>1-41010-1290</small>

(3) Precautions when starting the machine
(1-41010-1320)

⚠ WARNING
STARTING ENGINE AND MACHINE
<ul style="list-style-type: none"> • When starting engine, put the travel lever in the N position, and put parking brake lever or the switch in the STOP position. • When traveling the machine, always put the parking brake lever or the switch in the RUN position. • Ensure safety around the machine, sound the horn and start. • DO NOT operate abruptly: this means no starting abruptly, stopping abruptly or turning abruptly. Operating abruptly may cause the track to disengage or cause the machine to fall over.
<small>1-41010-1320</small>

(4) Precautions for periodic replacement parts
(A-02001-1020)

⚠ CAUTION
PERIODIC REPLACEMENT PARTS
<ul style="list-style-type: none"> • Periodically replace the parts described in the operation & maintenance manual
<small>A-02001-1020</small>

(5) Precautions for crawler adjustment valve
(2 locations, left and right) (1-41010-1270)

	⚠ WARNING
	<p style="text-align: center;">VALVE</p> <ul style="list-style-type: none"> • High pressure. DO NOT loosen the valve more than one turn. • Careless loosening will cause the valve to jump out.
	<small>1-41010-1270</small>

(6) Precautions for warming-up operation
(1-41010-1230)

⚠ CAUTION
WARMING-UP
<ul style="list-style-type: none"> • This machine must be properly warmed up, or the equipment will operate abnormally or unexpectedly, and may be damaged.
<small>1-41010-1230</small>

(7) Precautions when adding fuel
(1-41010-1280)

	⚠ DANGER
	<p style="text-align: center;">DIESEL FUEL</p> <ul style="list-style-type: none"> • Stop the engine when adding fuel. • Keep away from fire.
	<small>1-41010-1280</small>

(8) Precaution for diesel fuel
(1-12020-1310)

Only use diesel fuel!
<small>1-12020-1310</small>



(9) Precaution for oil inside the hydraulic tank
(1-41010-1250)



(10) Beware of rotating crawlers
(2 locations, left and right) (1-41010-1240)



(11) Beware of rotating fan and pulley
(1-41010-1260)

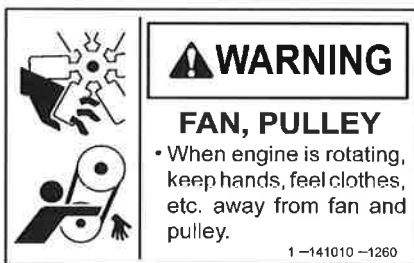

(12) Beware of high-temperature coolant
(1-41010-1300)



(13) Beware of high-temperature muffler
(1-41010-1220)



(14) Beware of electric shock
(1-68010-0290)



(15) Precautions for swing operation
(A-01601-2200)



(16) Warning to keep person clear from swing range (2 locations) (1-68010-0230)





(17) Caution for seat belt
(1-41010-1310)



(18) Clinometer
(A-03593-1000)

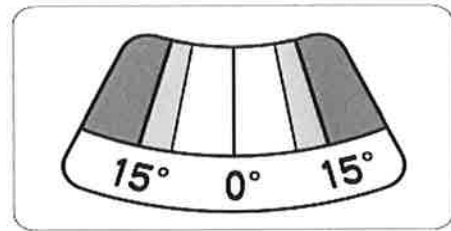

(19) Warning tag to prevent operation during
maintenance (1-41010-1210)







OPERATION

1. General view	2 - 2
2. Equipment	2 - 4
3. Operation	2 - 18
4. Handling dump body	2 - 38
5. Handling rubber crawler	2 - 41
6. Transportation	2 - 43
7. Cold weather operation	2 - 44
8. Long-term storage	2 - 46
9. Handling battery	2 - 47
10. Troubleshooting	2 - 50

1. GENERAL VIEW

1.1 GENERAL VIEW OF THE MACHINE

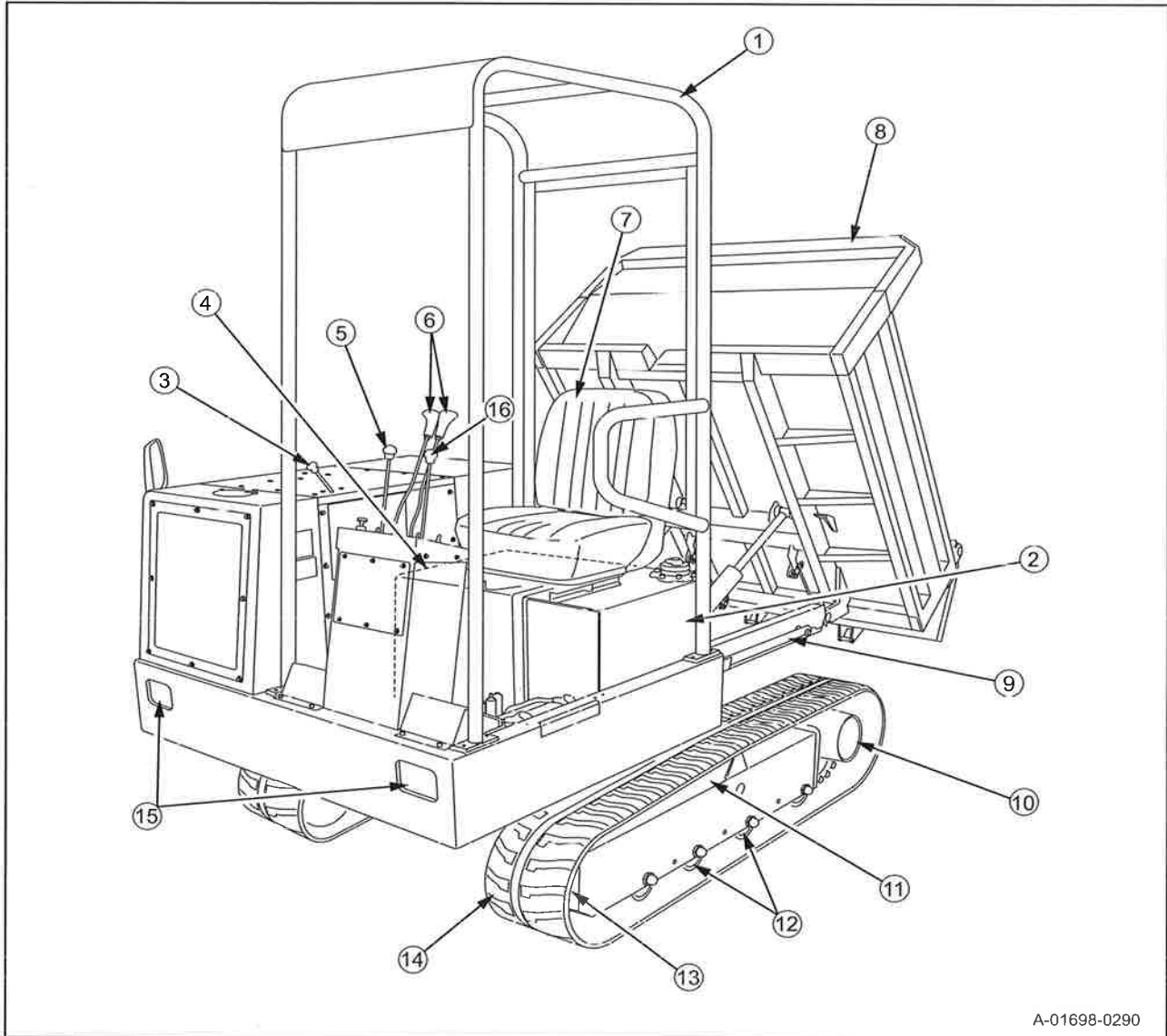

A-01698-0290

- | | | |
|---------------------------|-----------------------------|--------------------------|
| (1) ROPS canopy | (7) Operator's seat | (13) Front idler |
| (2) Fuel tank | (8) Dump body | (14) Rubber crawler |
| (3) Engine throttle lever | (9) Safety bar | (15) Headlight |
| (4) Hydraulic tank | (10) Travel motor, sprocket | (16) Swing control lever |
| (5) Dump control lever | (11) Carrier roller | |
| (6) Travel levers | (12) Track roller | |

1.2 GENERAL VIEW OF OPERATOR'S COMPARTMENT

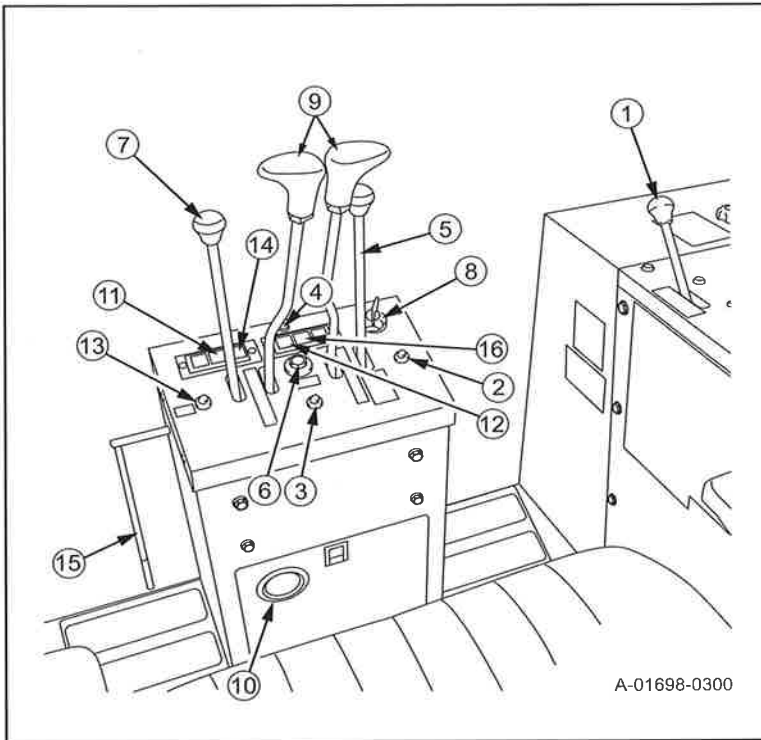

- (1) Engine throttle lever
- (2) Hi-Lo speed range selector switch
- (3) Lights switch
- (4) Forward center pilot lamp
- (5) Dump control lever
- (6) Horn switch
- (7) Swing control lever
- (8) Starting switch
- (9) Travel levers
- (10) Hour-meter
- (11) Battery charge lamp
- (12) Engine oil pressure warning lamp
- (13) Swing lock switch
- (14) Preheating indicator lamp
- (15) Safety lock lever
- (16) Engine water temperature warning lamp

★Position of (2) Hi-Lo speed range selector switch and (13) Swing lock switch may be reversed depending on the machine number. Check it before operating the machine.



2. EQUIPMENT

The following is an explanation of devices needed for operating the machine.

To carry out suitable operations correctly and safely, it is important to understand fully the methods of operating the equipment and the meanings of the displays.

2.1 CONTROL PANEL, METERS ON INSTRUMENT PANEL, LAMPS

[1] ENGINE WATER TEMPERATURE WARNING LAMP

Abnormal engine water temperature is warned.

- ★ If this warning lamp is lit, stop the engine and check for a water leak from the radiator, clogging of the radiator core, and damage and the tension on the fan belt.

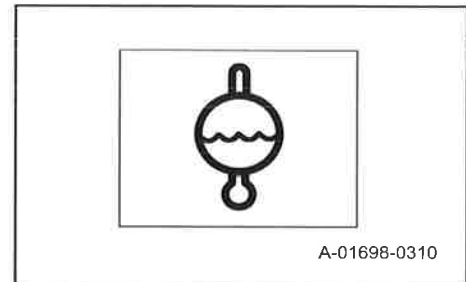

[2] HOUR-METER

This shows the total number of hours of the operation of the machine.

When the starting switch is at the ON position, the meter will advance even if the machine is not moving.

Use the hour-meter reading as the standard for periodic inspection and maintenance.

- ★ One digit at the right edge indicates tenths of an hour (6 minutes).
- ★ When you stop the engine, always turn the starting switch to the OFF position.

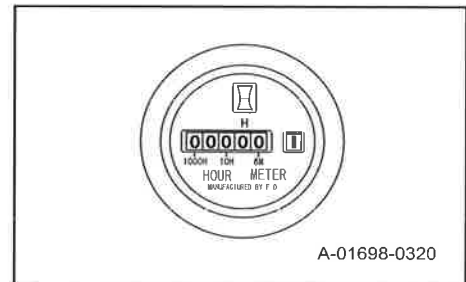

[3] ENGINE OIL PRESSURE WARNING LAMP

This lamp warns about a drop in the engine oil pressure.

During operation, this lamp should be off.

If the monitor lamp lights up during operation, the engine oil pressure has lowered.

- ★ When the monitor lamp lights up, immediately stop the operation and check for clogging of the engine oil filter and engine oil level.
- ★ If the inspection shows that there is no abnormality, please contact your distributor.

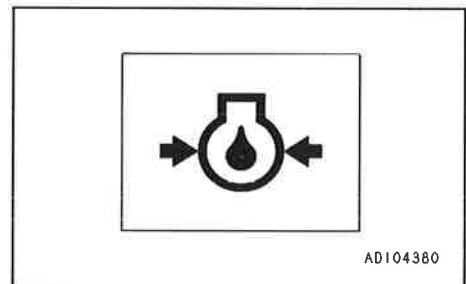

[4] BATTERY CHARGE LAMP

This shows the condition of the charging system.

It lights up when the starting switch is turned ON, and when the engine is started and the speed rises, it should go out.

If it lights up during operations, there is an abnormality in the charging system.

- ★ Stop the engine immediately and check for the problem. Check for the fan belt damage and the fan belt tension.
- ★ If the inspection shows that there is no abnormality, please contact your distributor.

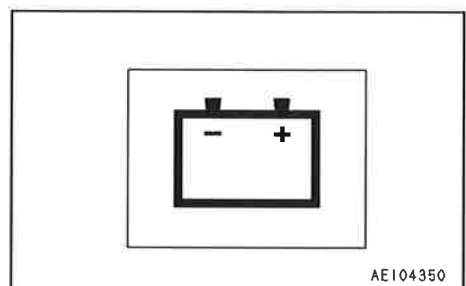



[5] HI-LO SPEED RANGE SELECTOR SWITCH

It displays the machine travel speed range.

When the Hi-Lo speed range selector switch is turned to the High speed position, the machine is set to the high speed range.

When the Hi-Lo speed range selector switch is turned to the Low speed position, the machine is set to the slow speed speed range.

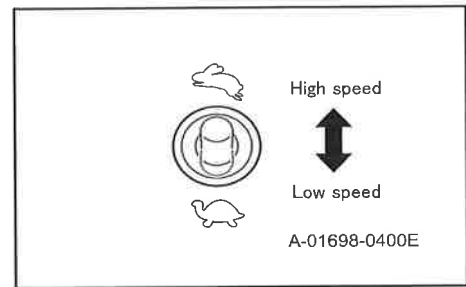

[6] PREHEATING INDICATOR LAMP

This lamp indicates preheating condition of the engine glow plug.

It lights up when the starting switch is turned ON; when it goes off, the engine preheating is finished.

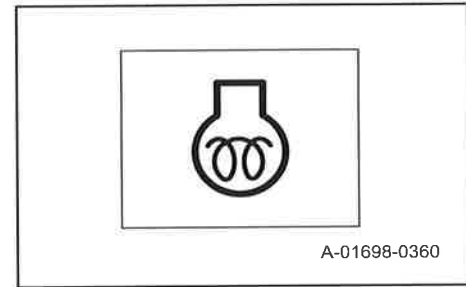

[7] FORWARD CENTER PILOT LAMP

It lights up when the forward position of the revolving upper structure faces to the arrow direction of the undercarriage and is in the center position. Normally, operate the machine when the forward center pilot lamp lights up.

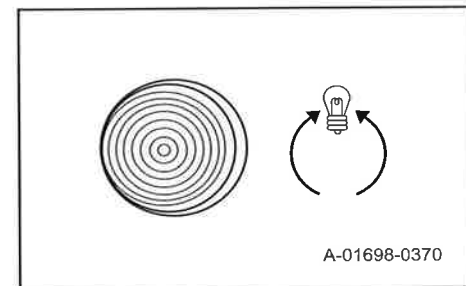

2.2 SWITCHES ON CONTROL PANEL

[1] STARTING SWITCH

This is used to start and stop the engine.

- **OFF:** The key can be inserted and removed at this position. When the key is turned to this position, all the switches for the electrical systems are turned off and the engine stops.
 - **ON/Preheating:** Electricity flows to the charging circuit and lamp circuit. Set this switch in this position under low ambient temperature to easily start the engine. When preheating is completed, the "preheating indicator lamp" on the control panel goes out. When the lamp goes out, set the starting key quickly to the **START** position to start the engine.
 - **START:** This is the position for starting the engine (the starting motor turns).
- ★ After the engine is started, do not turn the key to the OFF position except to stop the engine.

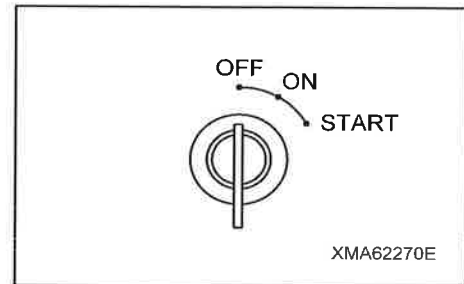

[2] ENGINE THROTTLE LEVER

NOTICE

- If the engine is stopped before it has cooled down properly, the service life of the engine parts may be reduced.
Never stop the engine suddenly except in cases of emergency.
- If the engine has overheated, do not stop it suddenly. Run the engine at a mid-range speed and gradually cool it down before stopping it.

This is used to control the engine speed and output.

- Pulled back: Engine runs at high speed
- Pushed forward: Engine runs at low speed

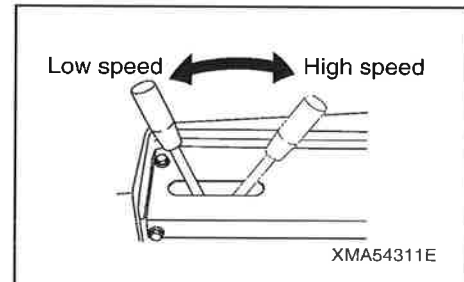

[3] HI-LO SPEED RANGE SELECTOR SWITCH

WARNING

- When traveling on slopes, always set the travel speed range to low speed. If the machine is driven in the high speed range, it may cause the engine to overrun.
- When traveling with a load, always set the travel speed range to low speed. If the loaded machine is driven in the high speed range, it may cause the engine to overheat.

This is used to select the travel speed range. The travel speed varies between the high-speed and low-speed ranges even when the engine speed is set at the same level and the travel levers are operated to the same amount.

- **High speed (toggle front):** The travel motor is set to the high speed range.
- **Low speed (toggle back):** The travel motor is set to the low speed range.

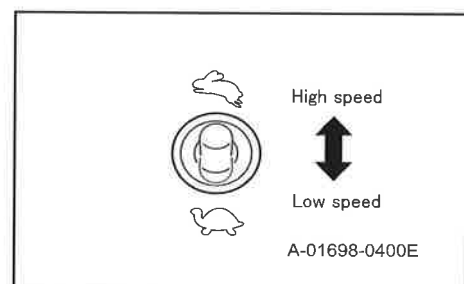



[4] LIGHTS SWITCH

This is used to operate the headlights and other lights.

- ON (toggle front): Headlights light up.
- OFF (toggle back): Headlights go out.

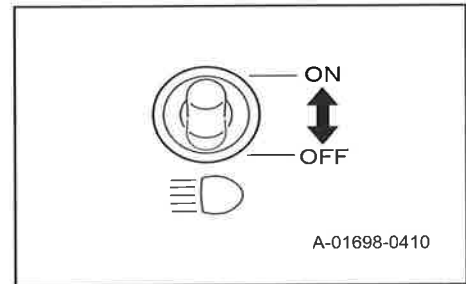

[5] HORN SWITCH

This is used to sound the horn.

- Press the center of the switch: Horn sounds.
- When the switch is released, the horn stops.

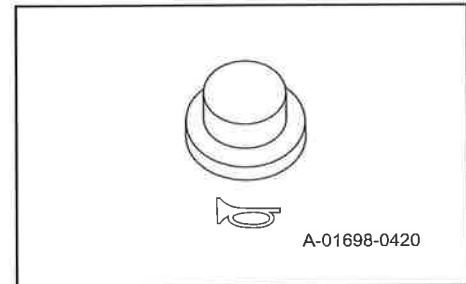

[6] SWING LOCK SWITCH

This is used to lock the revolving upper structure.

- OPEN (FREE): The revolving upper structure swings by operating the swing control lever.
 - LOCK: Swing function of the revolving upper structure is locked.
- ★ Set the swing lock switch to the LOCK position before traveling the machine.

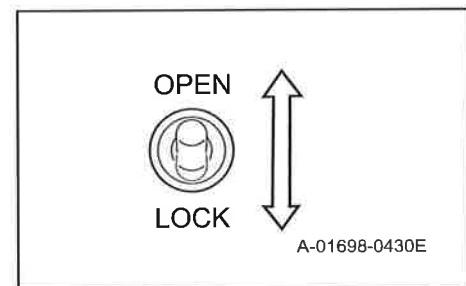

2.3 SAFETY LOCK LEVER

WARNING

- Before leaving the operator's seat, be sure to stop the engine and set the safety lock lever to the LOCK position (the safety lock lever is lowered).
- Before starting the engine, be sure to set the safety lock lever to the LOCK position and ensure that all control levers are in the N (neutral) position.
- When setting the safety lock lever to the FREE position while running the engine, never touch the swing control lever, dump control lever and travel levers.
- Never attempt to set the safety lock lever to the LOCK position while traveling, swinging and/or dumping operation.
Otherwise the control lever can not be returned to the N (neutral) position.

The safety lock lever is provided to prevent the machine from moving by unintentionally touching the swing control lever, dump control lever, or the travel lever when the operator gets in and out of the machine.

Further, setting the safety lock lever to the LOCK position facilitates the operator to get in and out of the operator's seat.

There are 2 operating positions such as LOCK and FREE.

- **LOCK:** Push down safety lock lever (1). This will disable the operation of the control levers and facilitate the operator to get to the operator's seat.
- **FREE:** Raise safety lock lever (1). This will enable the operation of the control levers, and the raised lever becomes a barrier for operator to get to the operator's seat.

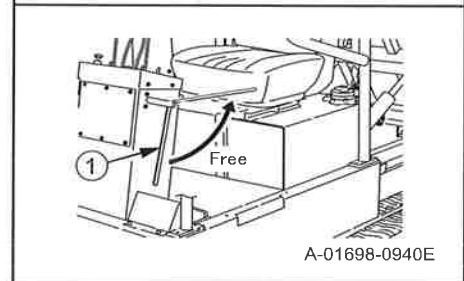
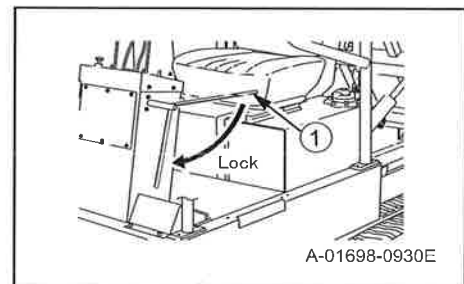

2.4 TRAVEL LEVERS

WARNING

- Set the swing lock switch to the LOCK position. When the revolving upper structure is not locked, if the machine travels on a rough ground or a slope, the revolving upper structure can move, causing an unexpected accident.
- Ensure the moving direction of the undercarriage structure before operating the travel lever. When the undercarriage structure direction is reversed (the sprocket is at the front side), the machine travels in the opposite direction of the lever operation, and the turning direction also reverses.
- Always stop the machine before switching the travel levers between FORWARD and REVERSE. If the direction of travel is suddenly changed, it may cause a failure such as reverse rotation of the engine.
- Do not operate the travel levers by a large amount suddenly. Always operate them slowly. If they are suddenly operated, the machine and the operator may suffer a large shock, resulting in malfunction or injury.
- When stopping the machine, do not return the travel lever past the N (neutral) position. If the lever is moved past the N (neutral) position, it will cause failure such as reverse rotation of the engine.
- Do not make unnecessary pivot/spin turns or sudden turns at high speed. This will damage the crawler and hydraulic equipment, and there is also danger that the machine may hit other objects.

- ★ The figure on the right shows the machine with revolving upper structure (1) facing in the opposite direction (rear) of undercarriage structure (2). In this condition, the forward center pilot lamp goes out. Since sprocket (A) of undercarriage structure (2) is located forward viewed from the operator's seat, the operating directions of the travel lever and pedal are opposite to the forward/reverse directions and turning directions (left turn and right turn) of the machine.
- Example:** If the travel lever is operated forward, the machine moves in reverse when viewed from the operator's seat.

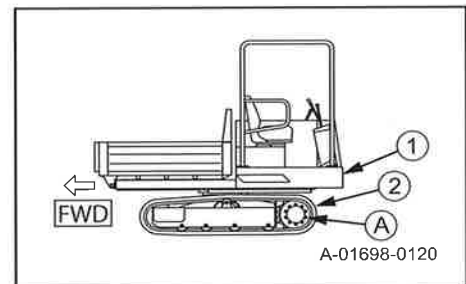

- ★ The figure on the right shows the machine with revolving upper structure (1) and undercarriage structure (2) facing in the same direction. In this condition, the forward center pilot lamp (green) lights up. Since the sprocket of undercarriage structure (2) is located rearward viewed from the operator's seat, the operating directions of the travel lever match the forward/reverse directions and turning directions (left turn and right turn) of the machine.

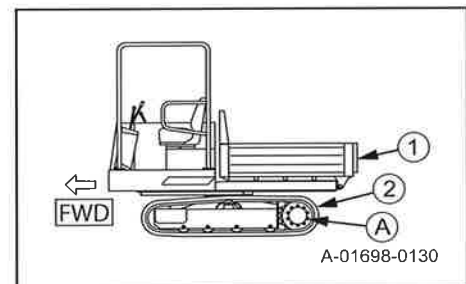

The travel levers are used to drive the machine in forward or reverse, to stop or steer the machine, and to control the travel speed.

[1] TRAVELING STRAIGHT OR STOPPING

- ★ When the revolving upper structure and undercarriage structure are facing opposite directions, forward and reverse operations of the lever are reversed.

Operate the left and right travel levers at the same time to the front or rear.

- FORWARD: Push the levers forward.
- REVERSE: Pull the levers back.
- STOP: Return the levers to the N (neutral) position.

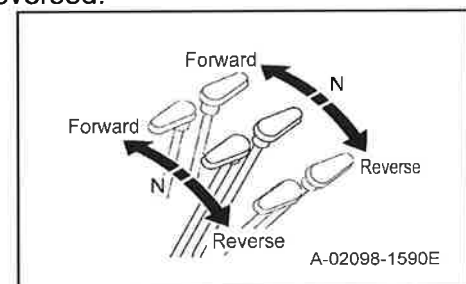



[2] TURNING (STEERING)

★ When the revolving upper structure and undercarriage structure are facing opposite direction, forward and reverse operations of the lever are reversed.

Operate the left and right travel levers at the same time, but operate one lever more than the other.

- Turning left when traveling forward: Push the right travel lever forward. Or, return the Left lever to the N (neutral) position.
- Turning right when traveling forward: Push the left travel lever forward. Or, return the right lever to the N (neutral) position.
- Turning left when traveling in reverse: Pull the Right lever back. Or, return the Left lever to the N (neutral) position.
- Turning right when traveling in reverse: Pull the Left lever back. Or, return the right lever to the N (neutral) position.

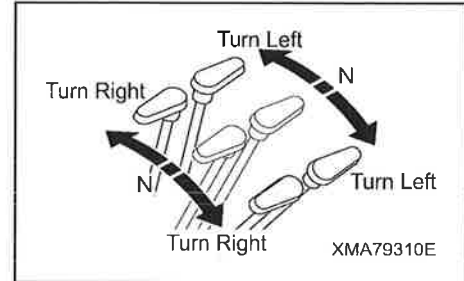

[3] GRADUAL AND RAPID TURN

Operate the left and right travel levers by a different amount.

If there is a big difference between the 2 levers, the machine turns rapidly. If there is a small difference between the 2 levers, the machine turns gradually.

[4] PIVOT TURN

★ When the revolving upper structure and undercarriage structure are facing opposite direction, forward and reverse operations of the lever are reversed.

There are two ways of making turns on the spot as follows:

- Pivot turn
Return one travel lever to the N position and operate the other travel lever in the direction of forward or reverse.

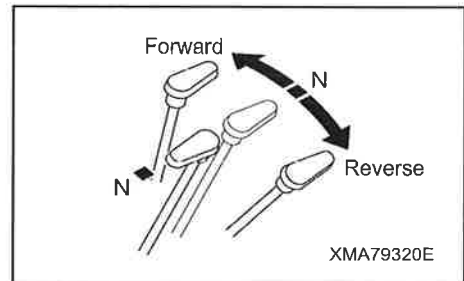

- Spin turn
Operate the left and right travel levers in opposite directions.

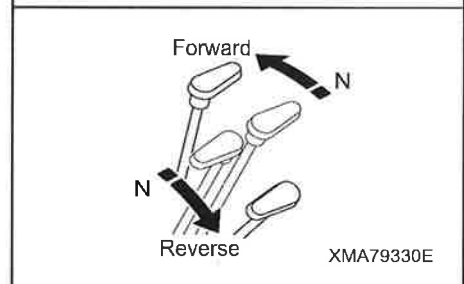

[5] CHANGING TRAVEL SPEED

Change the angle of the travel lever to change the speed.

Operate the travel lever a small amount to travel at low speed, and operate it a large amount to travel at high speed.

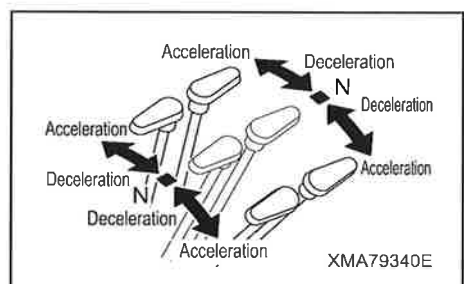

2.5 DUMP CONTROL LEVER

WARNING

- Always stop the machine before operating the dump body to the dumping position.
- Position a signalman to ensure safety in the surrounding area, and follow his signals when carrying out the dumping operation.
- Always operate the dump control lever slowly. If the dump body is suddenly stopped or it is allowed to hit the frame when it is lowered, it may cause a failure and compromise the safety in the surrounding area.
- When leaving the operator's compartment with the dump body raised, always set the safety lock lever to the LOCK position. In addition, use the safety bar to prevent the dump body from coming down. Even when the engine is stopped, it is possible to lower the dump body.

Dump control lever is used to raise and lower the dump body. There are 3 operating positions: RAISE, HOLD, and LOWER.

- RAISE: Pull the lever back. The dump body is raised.
 - HOLD: Return the lever to the position illustrated. The dump body stops moving and holds the position.
 - LOWER: Push the lever forward. The dump body is lowered.
- ★ When the control lever is released, it automatically returns to the HOLD position.

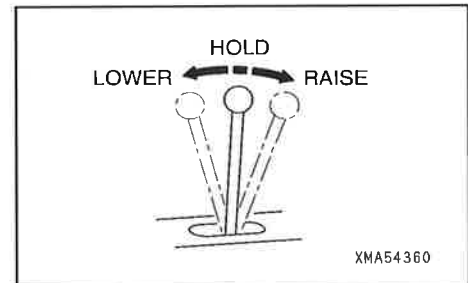

2.6 SWING CONTROL LEVER

WARNING

- Always park the machine on a level surface before swinging the revolving upper structure. When swinging the machine from higher to lower direction on a slope, swing speed of the revolving upper structure increases due to gravity.
- When there are persons or obstacles in the area around the machine, always position a signalman and follow the signals to swing the revolving upper structure.
- Always operate the swing control lever slowly. Never attempt to swing the loaded revolving upper structure in high speed or rapidly stop swinging. Failure to do so may cause a failure and impair the safety in the surrounding area.
- When leaving the machine, always stop the engine. And then, set the safety lock lever to the LOCK position.

The swing control lever is used to swing the revolving upper structure.

There are 3 operating positions: L Swing, HOLD, and R Swing.

- **LEFT TURN:** Pull the lever back.
The revolving upper structure swings leftward (counterclockwise).
- **HOLD:** Return the lever to the position illustrated.
The revolving upper structure stops swinging and holds the position.
- **RIGHT TURN:** Push the lever forward.
The revolving upper structure swings rightward (clockwise).

★ When the control lever is released, it automatically returns to the HOLD position.

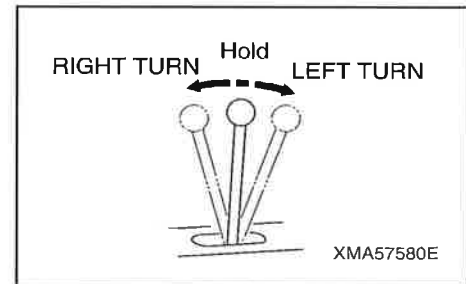

2.7 DUMP BODY SAFETY BAR

WARNING

- If it is necessary to go under the dump body to carry out inspections and maintenance, always use the safety bar to prevent the dump body from coming down.
- When using the safety bar, check that the bar is fitted securely to the dump body holder.
- The safety bar is a safety device used during inspections and maintenance. Do not use the safety bar to support the dump body when replacing equipment that holds the dump body such as the dump cylinder, valve, and hydraulic hoses. In such cases, always support the dump body with a crane.

Safety bar (1) is a device used to ensure safety during operations.

Always use the safety bar when going under the dump body to carry out inspections and maintenance.

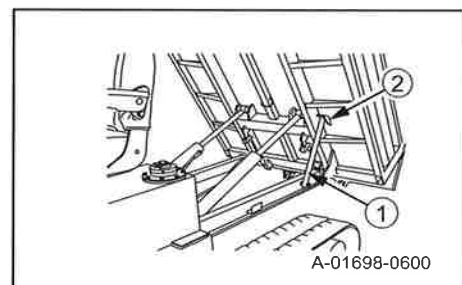



2.8 FUSE BOX IN ELECTRICAL COMPONENT COVER

CAUTION

- Always turn the starting switch to the OFF position before replacing a fuse.
- If a fuse is blown, always check for the cause in that circuit and carry out repairs before replacing the fuse.
- When replacing a fuse, always replace it with a fuse of the same capacity.

NOTICE

Fuses are devices that prevent electrical component and wiring from burning out. If a fuse is corroded or covered in white powder, always replace it.

1. Open electrical component cover (1).

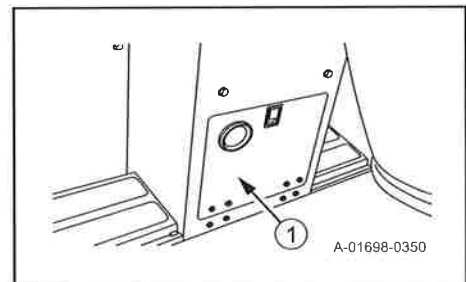

2. Open the cover of fuse box (2).
3. Check the fuse and replace it if necessary.

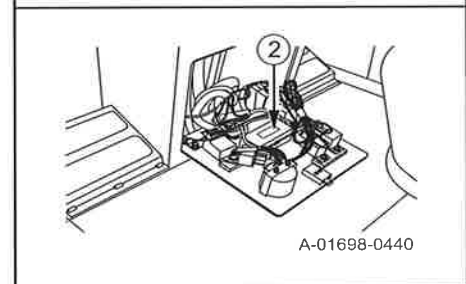

4. The fuses inside the fuse box are for the circuits shown in the table below.

No.	Capacity	Name of circuit
1	5A	Fuel pump
2	5A	Glow circuit
3	10A	Headlight
4	3A	Hour meter
5	3A	Glow plug relay, glow timer
6	10A	Horn
7	10A	Travel speed selector switch, swing lock switch
8	3A	Pilot lamp
9	10A	Spare fuse
10	5A	Spare fuse
11	3A	Spare fuse

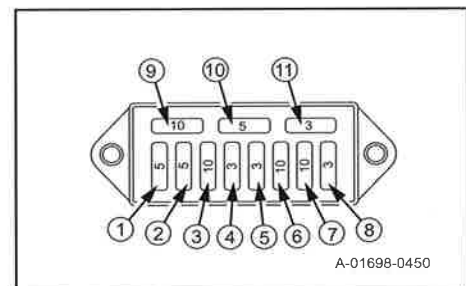

2.9 FUSES INSIDE WIRING HARNESS

⚠ CAUTION

- Always turn the starting switch to the OFF position before replacing a fuse.
- If a fuse is blown, always check for the cause in that circuit and carry out repairs before replacing the fuse.
- When replacing a fuse, always replace it with a fuse of the same capacity.

NOTICE

Fuses are devices that prevent electrical component and wiring from burning out. If a fuse is corroded or covered in white powder, always replace it.

[1] FUSIBLE LINK OF CHARGING SYSTEM

Check this fusible link (1) when the battery charge lamp remains ON during operation. Replace it when necessary.

★ Fuse capacity: 65 A

1. Open engine cover (3).

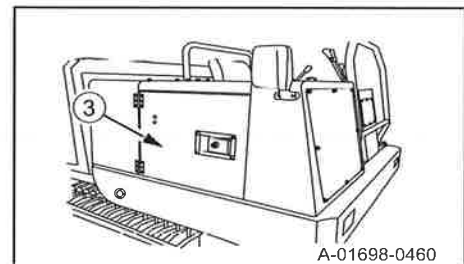

2. Release the lock. Remove fusible link (1).
3. Remove the transparent cover. Check inside fuses.
4. If any abnormality of the fuse(s) was found as the result of inspection, replace the whole case assembly.

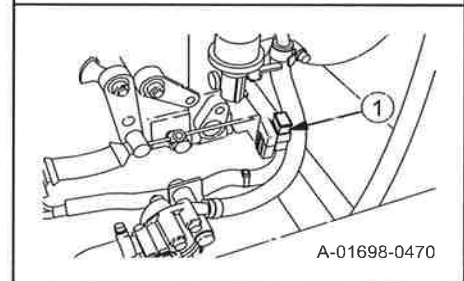

[2] MINI-FUSE FOR ENGINE START SYSTEM

Check this mini-fuse (2) when the engine can not be started. (The starter does not operate.) Replace it if necessary.

★ Fuse capacity: 10 A

1. Open engine cover (3).
2. Open the cap. Check the fuse.
3. If any abnormality of the fuse(s) was found as the result of inspection, replace the whole case assembly.

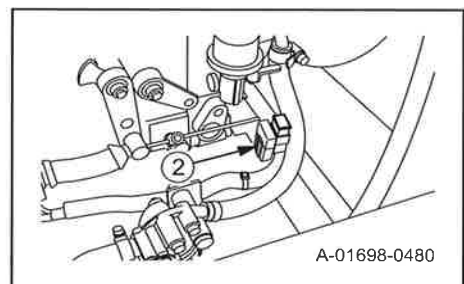

2.10 OPERATOR'S SEAT

WARNING

- Adjust the operator's seat before starting operations. Always adjust the operator's seat after it has been used by another operator.
- Adjust the (front-rear) slide of the operator's seat so that you can operate the travel levers easily with your back against the seat backrest.
- Never adjust the seat when traveling, swinging, or dumping the machine.

[1] ADJUSTMENT OF SEAT (FRONT-REAR SLIDE)

Be sure to adjust the front-rear position of the seat by using lever (3) at the right front bottom of the seat with the operator being seated.

1. Keep lever (3) pulled rightward and move the seat to the front or rear.
2. After adjusting, release lever (3). Slightly push the seat to lock it.

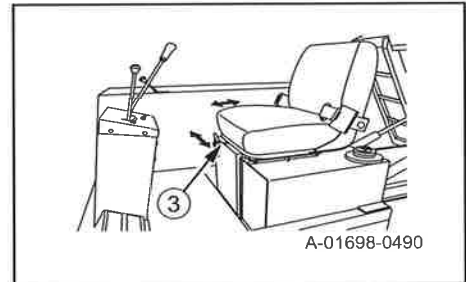

2.11 SEAT BELT

WARNING

- Before fastening the seat belt, always check that there are no abnormalities in the belt mount or seat belt clamps. If there is any wear or damage, always replace the seat belt with a new one.
- Always adjust and fasten the seat belt before starting operations. The seat belt is installed to prevent the operator from falling out of the operator's seat if the machine tips at an angle when traveling.
- Do not wear twisted seat belts (left and right).
- Replace the seat belt with a new one every 3 years regardless of appearance.

NOTICE

When the seat belt has been used for a long period, and the belt is damaged or starting to become fluffy, or if the tongue/clamps are broken or distorted, replace with a new seat belt.

[1] FASTENING AND REMOVING SEAT BELT

1. Sit in the operator's seat, push your back against the backrest, and adjust the operator's seat to a position where it is possible to operate the travel levers easily. For details, see "2.10 OPERATOR'S SEAT in OPERATION".

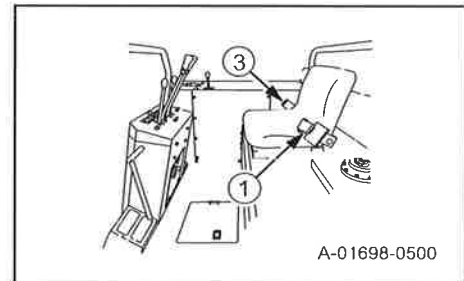

2. Hold tongue (2) of seat belt (1) by hand and pull out seat belt (1) slowly.
3. Fit seat belt (1) as low as possible across your hips and fit it to your body so that there is no slack.

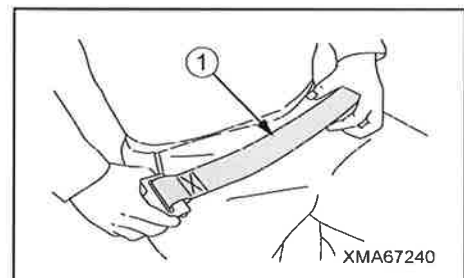

4. Insert tongue (2) into buckle (3) so that seat belt (1) is not twisted.
5. Pull seat belt (1) and check that tongue (2) and buckle (3) are securely locked.

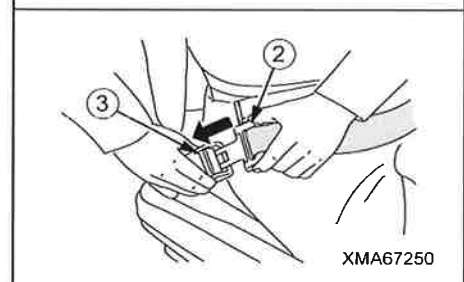

6. When removing seat belt (1), push in tip (4) of buckle (3) and pull out tongue (2).

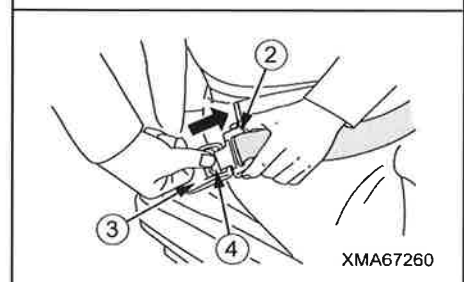

2.12 ENGINE COVER

When carrying out inspections and maintenance of the engine parts, radiator and oil cooler fin, open the engine cover by following the below instructions.

1. Release lock (1) by using the dedicated key. Open engine cover (3) rearward.
2. After carrying out inspections and maintenance, close engine cover (3) forward and engage lock (1) by using a dedicated key.

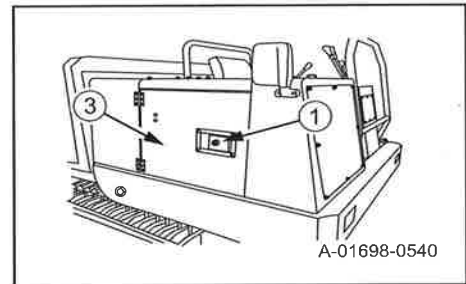

2.13 OPERATOR'S SEAT SIDE COVER

When carrying out inspections and maintenance around the fan belt, remove the operator's seat side cover by following the below instructions.

1. Remove 8 bolts (1) and remove side cover (2).
2. After carrying out inspections and maintenance, set side cover (2) to the original position. Tighten bolts (1).

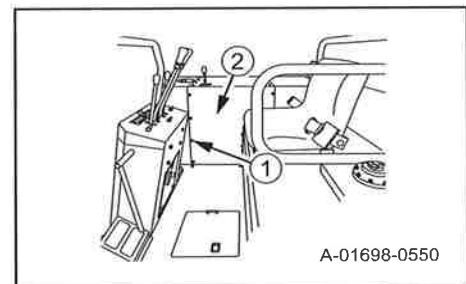

2.14 BATTERY INSPECTION COVER

When carrying out inspections and maintenance of the battery parts, do as follows to open the battery inspection cover.

1. Grab handle (2) of battery inspection cover (1) and lift up the cover.
2. After completing inspections and maintenance, close battery inspection cover (1).

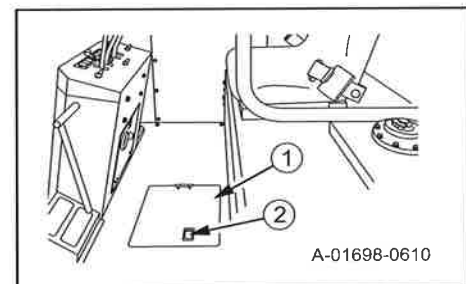

3. OPERATION

3.1 CHECK BEFORE STARTING ENGINE

[1] WALK-AROUND CHECKS

! WARNING

- Thoroughly check the muffler, and other engine parts which reach high temperatures and around the battery for dead leaves, waste paper, oil, grease, and other flammable items. These flammable items can cause a fire.
- Thoroughly check the hydraulic and fuel hoses for oil and fuel leaks. If any cracks, deformation, or other abnormalities are found, repair them immediately. These problems can cause a fire, travel failure, or problems with raising or lowering the dump body.
- Always use the handrails and steps when getting on or off the machine.

Before starting the engine at the beginning of the day's work, look under and around the machine to check the following points.

- Check for dead leaves, waste paper, dust, oil, or grease at places which reach high temperatures.
- Check for loose or missing bolts, nuts, or connecting pins.
- Check for oil, fuel, or coolant leaks.
- Check for hanging electrical wires or loose connections.

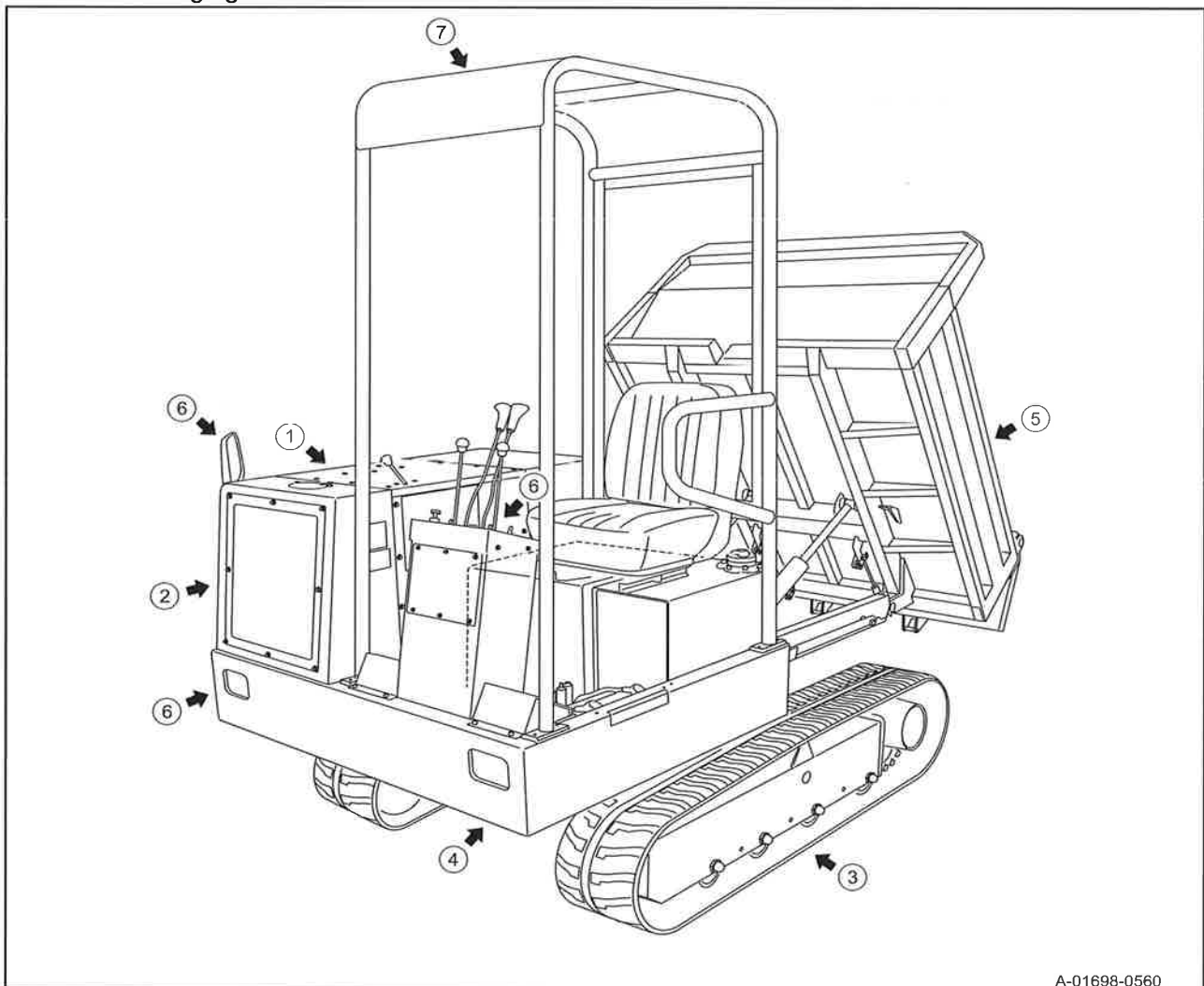

A-01698-0560

**(1) Check inside engine room**

Check for dead leaves, waste paper, dust, oil, grease, or other flammable items, and check for fuel, oil, or coolant leaks from the engine. Remove any flammable items and repair any abnormalities.

Check for hanging electrical wires, loose connections, or signs of burns around the starting motor, alternator, battery, and battery relay. Repair any abnormalities.

(2) Check inside front grill

Check the front surface of the radiator, and oil cooler for dead leaves, waste paper, dust, or other flammable items or materials which can cause clogging. Remove any such materials.

(3) Check undercarriage (rubber crawler, track roller, carrier roller, sprocket, idler)

Check for any wear, breaks, or cracks. Check for any loose or missing nuts or bolts. Tighten if necessary and repair any abnormalities.

(4) Check under machine

Check the hydraulic tank and fuel tank for leakage, and check the ground under the machine for traces of oil, fuel, or coolant. If any signs of leakage are found, check for the source of the leakage and repair any abnormalities.

(5) Check dump body, safety bar

Check for any wear, breaks, or cracks. Check for any loose or missing nuts, bolts, or connecting pins. Tighten if necessary and repair any abnormalities.

Check for any leakage of oil from the hydraulic hoses or hydraulic cylinders, and repair any abnormalities.

(6) Check mirrors, lamps, instrument panel

Check for any damage to the mirrors, lamps, meters, or monitor panel, and repair or replace if there is any abnormalities.

(7) Check ROPS canopy

Check for any breaks, or cracks. Check for any loose or missing nuts, bolts. Tighten if necessary and repair any abnormalities.



[2] CHECKS BEFORE STARTING

Before starting the engine at the beginning of the day's work, carry out the following checks before starting and checks when required.

For details on the checks before starting and checks when required, see "MAINTENANCE".

1. Checks when required

- (1) Check and adjust the rubber crawler tension
- (2) Check the rubber crawler for damage and wear
- (3) Check, clean or replace the air cleaner
- (4) Clean inside of the cooling system and change coolant
- (5) Check and clean the radiator and oil cooler fins.

2. Checks before starting

- (1) Check the coolant level and add coolant if necessary.
- (2) Check the fuel level and add fuel
- (3) Check the engine lubrication oil level and add oil
- (4) Check the amount of oil in the hydraulic tank and add oil
- (5) Check the fan belt tension and adjust
- (6) Check the electrical wire
- (7) Check operation of switches, lamps, and gauges
- (8) Check operation of the horn

[3] ADJUST OPERATOR'S SEAT

WARNING

- **Adjust the operator's seat before starting operations. Always adjust the operator's seat after it has been used by another operator.**
- **Adjust the (front-rear) slide of the operator's seat so that you can operate the travel levers easily with your back against the seat backrest.**
- **Never adjust the seat when traveling, swinging, or dumping the machine.**

For details, see "2.10 OPERATOR'S SEAT in OPERATION".



3.2 OPERATIONS AND CHECKS BEFORE STARTING ENGINE

1. Check the following items before riding on the machine.

- (1) Ensure that the dump body is completely lowered.
- (2) Ensure that revolving upper structure (1) and undercarriage structure (2) are facing in the same direction.

★ The figure on the right shows the machine with revolving upper structure (1) and undercarriage structure (2) facing in the same direction. Since sprocket (A) of undercarriage structure (2) is located rearward viewed from the operator's seat, the operating directions of the travel lever are opposite to the forward/reverse directions and turning directions (left turn and right turn) of the machine.

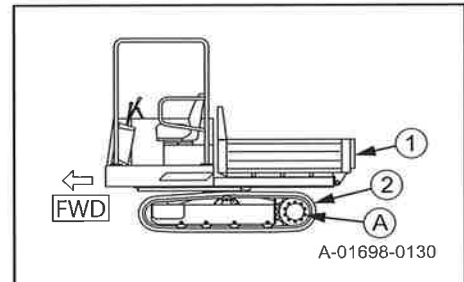

★ The figure on the right shows the machine with revolving upper structure (1) and undercarriage structure (2) facing in the opposite direction. Since sprocket (A) of undercarriage structure (2) is located forward viewed from the operator's seat, the operating directions of the travel lever are opposite to the forward/reverse directions and turning directions (left turn and right turn) of the machine.

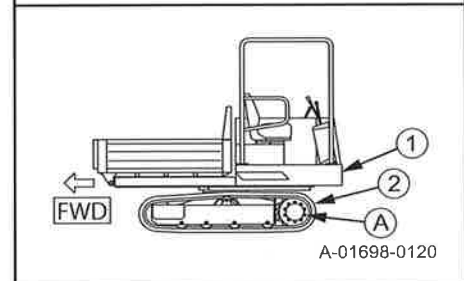

2. Ensure that the left and right travel levers are at the N(neutral) position.

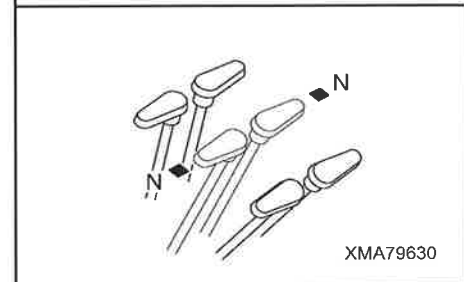

3. Ensure that the swing lock switch on the control panel is at the LOCK position.

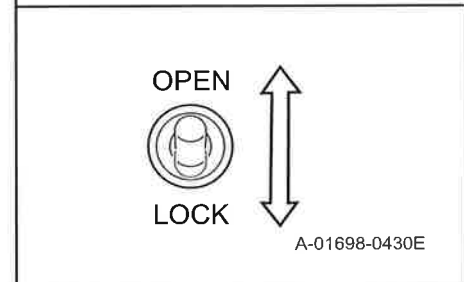

4. Ensure that the swing control lever and dump control lever are at the HOLD position.

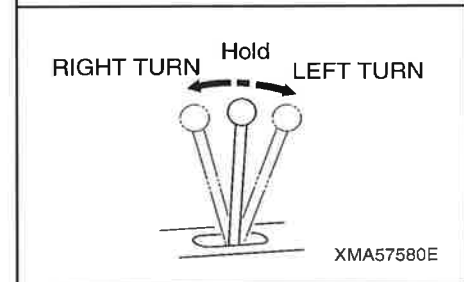

5. Ensure that the safety lock lever is at the LOCK position.

3.3 STARTING ENGINE

WARNING

Check that there are no persons or obstacles in the surrounding area, then sound the horn and start the engine.

NOTICE

Do not crank the starting motor continuously for more than 10 seconds. If the engine does not start, wait for at least 30 seconds before starting again.

[1] STARTING ENGINE IN NORMAL WEATHER

1. Pull the throttle lever back to the mid-range speed.

Low speed → Mid-range speed

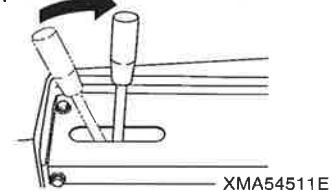

XMA54511E

2. Insert the key in the starting switch, turn it to the ON position. The “preheating indicator lamp” on the control panel lights up. When preheating is completed, the lamp goes out. Wait until the lamp goes out.

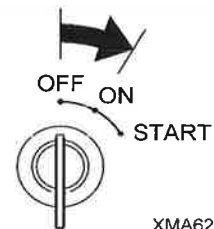

XMA62950E

3. When the “preheating indicator lamp” on the control panel goes out, turn the key to the START position to start the engine.

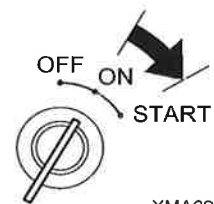

XMA62960E

4. After the engine starts, release the key.

★ The key automatically returns to the ON position.

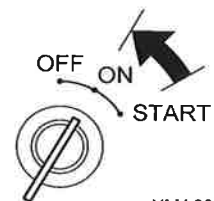

XMA62970E



[2] STARTING ENGINE IN COLD WEATHER

Follow the procedure given below when starting the engine in cold weather.

1. Fully pull the throttle lever back to the high speed range.

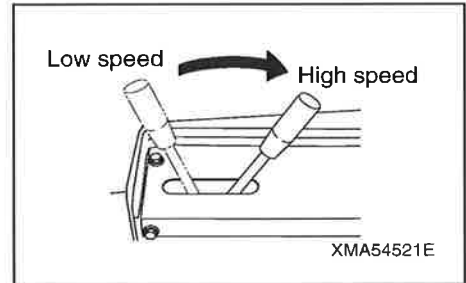

2. Insert the key in the starting switch, turn it to the ON position. The preheating indicator lamp on the control panel lights up. When preheating is completed, the lamp goes out. Wait until the lamp goes out.

★ When the ambient temperature is -5°C or lower, preheat approximately 5 seconds after the "preheating indicator lamp" goes out.

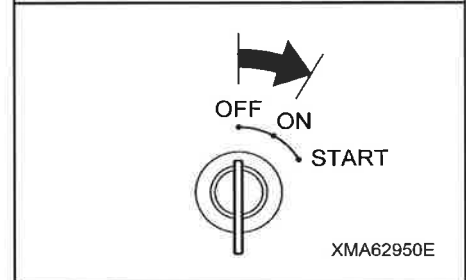

3. When the "preheating indicator lamp" on the control panel goes out, turn the key to the START position to start the engine.

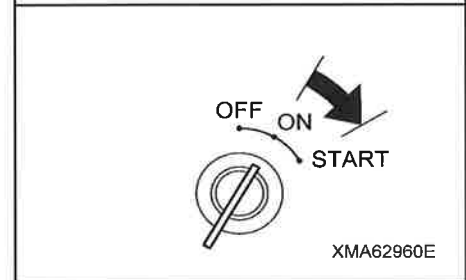

4. After the engine starts, release the key.

★ The key automatically returns to the ON position.

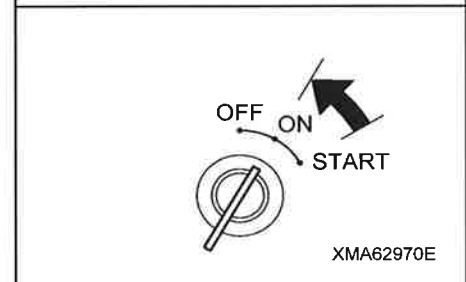

[3] AFTER STARTING (Warming-up operation)

NOTICE

After the warming-up operation, run the engine under light load until the engine water temperature and hydraulic oil temperature stabilize. Do not suddenly accelerate the engine.

When the engine starts, carry out the warming-up operation as follows.

1. Push the throttle lever forward, set the engine to low speed, and run for approx. 5 minutes under no load.

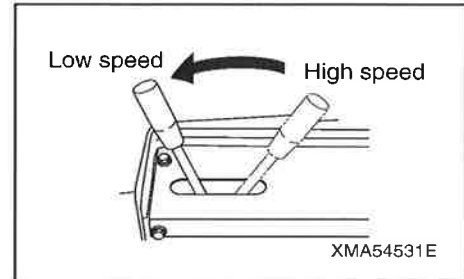

2. Pull the throttle lever back, raise the engine speed to a mid-range speed, and run for approx. 5 minutes under no load.

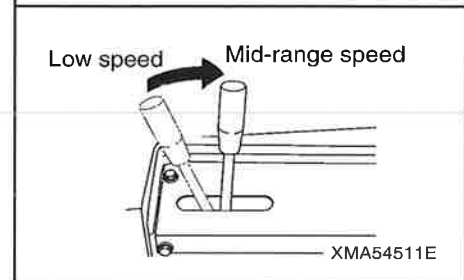

3. Set the dump control lever to the RAISE position, raise the dump body to the maximum height, and run the engine for approx. 5 minutes.

★ Keep the dump control lever at the RAISE position.

4. Keep the dump control lever at the RAISE position, turn the engine throttle lever to the back further to run the engine at high speed, and run the engine in this condition for 2 - 5 minutes.

This operation warms up the hydraulic oil and makes the operation of the travel and dump body smooth.

5. Check that the meters on the instrument panel and the monitor lamps work normally.
6. Check that there is no abnormality in the exhaust gas color, engine noise, or vibration.

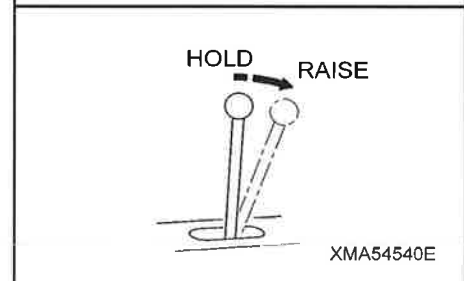

3.4 MOVING MACHINE

WARNING

- Set the swing lock switch to the LOCK position.
When the revolving upper structure is not locked, if the machine travels on a rough ground or a slope, the revolving upper structure can move, causing an unexpected accident.
- Before starting to move the machine, ensure the surrounding area is safe. Check particularly carefully around the dump body at the rear of the machine.
- Before starting to move the machine, ensure the surrounding area is safe, and sound the horn to inform people that you are starting.
- Ensure the moving direction of the undercarriage structure before operating the travel lever. When the undercarriage structure direction is reversed (the sprocket is at the front side), the machine travels in the opposite direction of the lever operation and the turning direction also reverses.
- Check that the forward center pilot lamp (green) lights up.
When the forward center pilot lamp (green) lights up, the revolving upper structure and undercarriage structure are facing right in front. Also, the revolving upper structure and under-carriage structure are mutually in parallel.
- When turning the travel levers to a large extent, the machine will start suddenly. Operate the travel levers slowly to prevent a sudden start.
- When starting the machine on a slope, be sure to select the low-speed range for travel speed. Also, when traveling on a slope, keep the machine facing straight forward.
- When starting uphill on slopes, always start in the low speed range and run the engine at high speed. Keep the travel lever as close as possible to the N (neutral) position.
- Never attempt to set the safety lock lever to the LOCK position while traveling. Otherwise the travel lever is locked in the travel position, and the machine cannot be stopped, causing serious accident.
- When traveling downhill in forward gear, take care not to allow the machine to travel with "9 deg." and above by checking the clinometer located at the right side of the operator's seat.
When the clinometer reads an angle close to "9 deg.", switch course to one with a gentler incline. In addition, lower the engine speed to a low speed, set the travel lever close to "Neutral" position, and operate the machine carefully.
- If a dangerous state occurs by any possibility, and when it becomes necessary to stop the machine urgently, set the travel levers to the N (neutral) position. Or turn the starting switch to the OFF position to stop the machine.

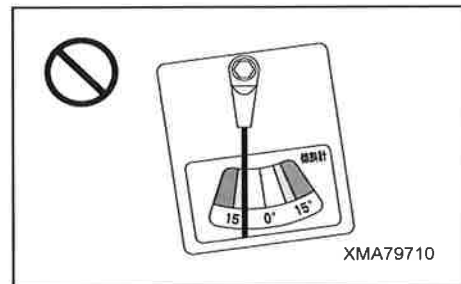

- ★ When the forward center pilot lamp (green) lights up, sprocket (A) is located backward, so operating directions for forward/reverse and machine travel direction are the same.

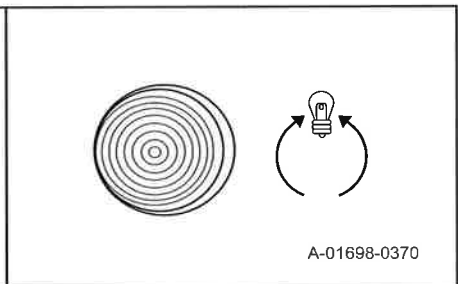
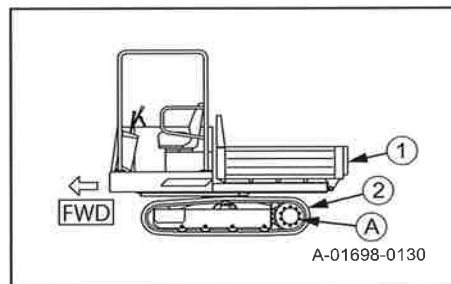



★ When sprocket (A) is located forward, operating directions for forward/reverse and machine travel direction are reversed.

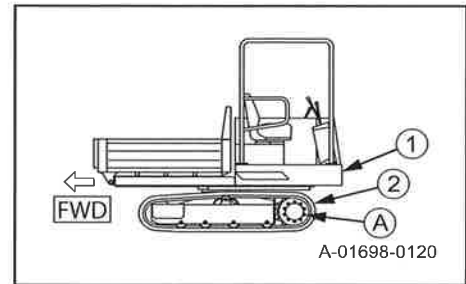

To start moving the machine, do as follows.

1. Ensure that the travel lever, swing control lever, and dump control lever are in the N (neutral) position. Set safety lock lever (1) to the FREE position.

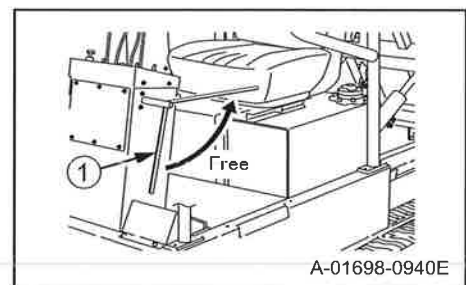

2. Pull the throttle lever back, run the engine at a mid-range speed.

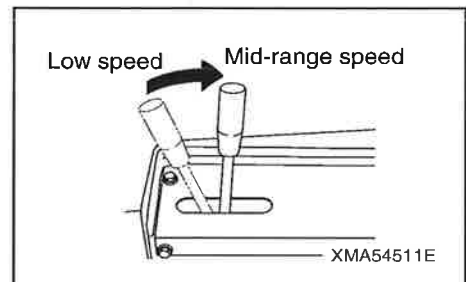

3. Operate the left and right travel levers gradually and move the machine slowly.

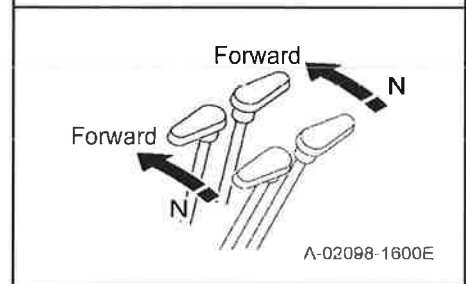



3.5 SHIFTING SPEED RANGE AND CHANGING BETWEEN FORWARD AND REVERSE

WARNING

- Ensure the moving direction of the undercarriage structure before operating the travel lever. When the undercarriage structure direction is reversed (the sprocket is at the front side), the machine travels in the opposite direction of the lever operation and the turning direction also reverses.
- When traveling, select a travel speed to match the travel surface and ground condition.
- Check that the forward center pilot lamp (green) lights up. When the forward center pilot lamp (green) lights up, the revolving upper structure and undercarriage structure are facing right in front. Also, the revolving upper structure and undercarriage structure are mutually in parallel.
- When traveling on a slope, be sure to set the travel speed range to the low speed range. Also, when traveling on a slope, travel straight forward.
- When going down a slope, always travel in the low speed range. Run the engine at low speed and operate the travel lever a maximum of half way from the N (neutral) position. Traveling at excessive speed is dangerous and will cause overrunning.
- When traveling up a slope, always travel in the low speed range. Run the engine at the rated speed and keep the travel lever close to the N (neutral) position.
- If a dangerous state occurs by any possibility, and when it becomes necessary to stop the machine urgently, set the travel levers to the N (neutral) position. Turn the starting switch to the OFF position to stop the machine.
- When switching between FORWARD and REVERSE, always stop the machine before shifting direction. If the direction of travel is shifted suddenly between FORWARD and REVERSE, it will cause failures such as reverse rotation of the engine.
- When switching the travel speed range, always stop the machine first before operating the switch.
- Never attempt to set the safety lock lever to the LOCK position while traveling. Otherwise the travel lever is locked in the travel position, and the machine cannot be stopped, causing serious accident.
- When traveling downhill in forward gear, take care not to allow the machine to travel with "9 deg." and above by checking the clinometer located at the right side of the operator's seat. When the clinometer reads an angle close to "9 deg.", switch course to one with a gentler incline. In addition, lower the engine speed to a low speed, set the travel lever close to the N (neutral) position, and operate the machine carefully.
- If a dangerous state occurs by any possibility, and when it becomes necessary to stop the machine urgently, set the travel levers to the N (neutral) position. Or turn the starting switch to the OFF position to stop the machine.

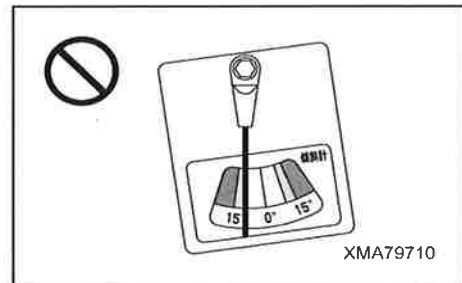

- ★ When the forward center pilot lamp (green) lights up, sprocket (A) is located backward, so operating directions for forward/reverse and machine travel direction are the same.

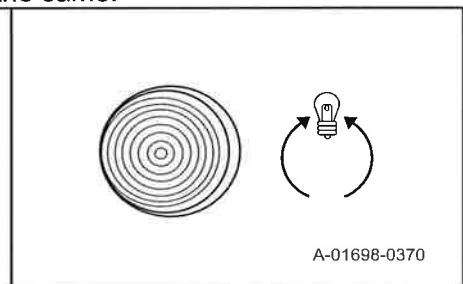
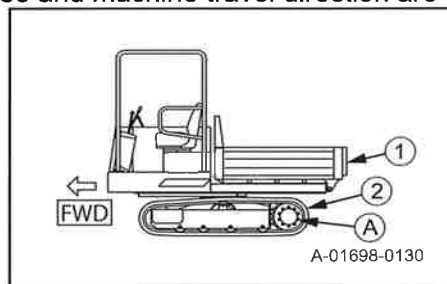



- ★ When sprocket (A) is located forward, operating directions for forward/reverse and machine travel direction are reversed.

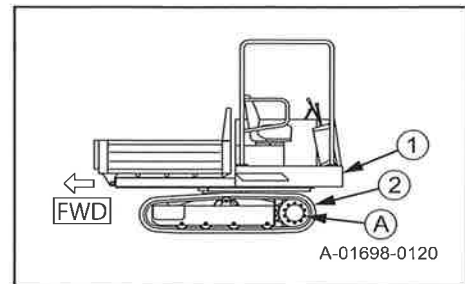

[1] CHANGING SPEED

The travel speed can be changed by changing the amount that the left and right travel levers are operated.

- The closer the left and right travel levers are to the N (neutral) position, the lower the travel speed.
- The further the left and right travel levers are from the N (neutral) position, the higher the travel speed.

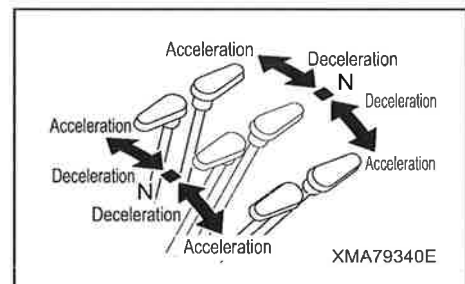

[2] SHIFTING BETWEEN FORWARD AND REVERSE

The direction of travel can be adjusted by changing the direction of travel levers operations.

- When the left and right travel levers are pushed forward, the machine will travel forward.
- When the left and right travel levers are pulled back, the machine will travel in reverse.
- ★ When the undercarriage structure direction is reversed (the sprocket is at the front side), the machine travels in the opposite direction of the lever operation.

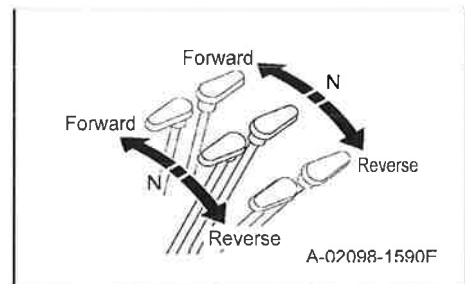

[3] SWITCHING BETWEEN HI AND LO SPEED RANGES

The travel speed range is changed by operating the Hi-Lo speed range selector switch.

- When the switch is turned to the Hi speed position (toggle front), the mechanism inside the travel motor is switched and the machine changes to the high speed range.
- When the switch is turned to the LO speed position (toggle back), the mechanism inside the travel motor is switched and the machine changes to the low speed range.

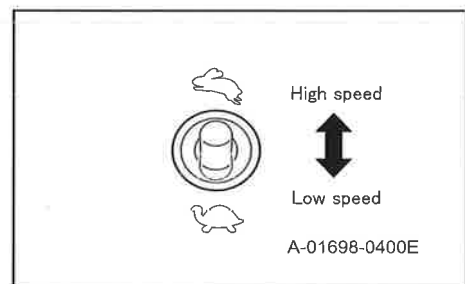

3.6 STEERING MACHINE

⚠ WARNING

- Ensure that the forward center pilot lamp (green) lights up. When the forward center pilot lamp (green) lights up, the revolving upper structure and undercarriage structure are facing right in front. Also, the revolving upper structure and undercarriage structure are mutually in parallel.
- Ensure the moving direction of the undercarriage structure before operating the travel lever. When the undercarriage structure direction is reversed (the sprocket is at the front side), the machine travels in the opposite direction of the lever operation and the turning direction also reverses.
- Do not turn the machine sharply at high speed (right, left); do not carry out a spin turn unless necessary. This will damage the crawler and hydraulic equipment, and there is also danger that the machine may hit other objects.
- Avoid turning direction (left turn/right turn) on a slope as much as possible because the machine may sideslip. Be particularly careful about turning direction on soft ground or clay-rich ground.
- Never attempt to set the safety lock lever to the LOCK position while traveling. Otherwise the travel lever is locked in the travel position, and the machine cannot be stopped, causing serious accident.
- When traveling downhill in forward gear, take care not to allow the machine to travel with "9 deg." and above by checking the clinometer located at the right side of the operator's seat. When the clinometer reads an angle close to "9 deg.", switch course to one with a gentler incline. In addition, lower the engine speed to a low speed, set the travel lever close to the N (neutral) position, and operate the machine carefully.
- If a dangerous state occurs by any possibility, and when it becomes necessary to stop the machine urgently, set the travel levers to the N (neutral) position. Or turn the starting switch to the OFF position to stop the machine.

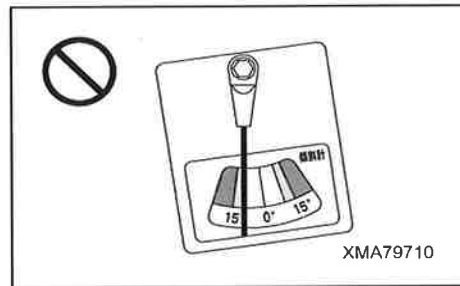

- ★ When the forward center pilot lamp (green) lights up, sprocket (A) is located backward, so operating directions for forward/reverse and machine travel direction are the same.

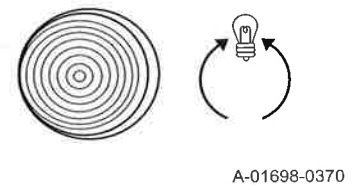
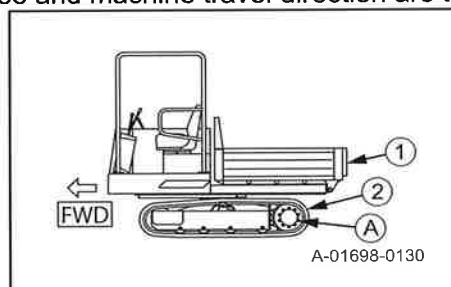

- ★ When sprocket (A) is located forward, operating directions for forward/reverse and machine travel direction are reversed.

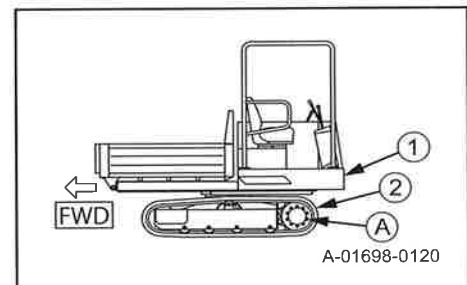



[1] GRADUAL AND RAPID TURN

The radius of the turn is determined by the difference in the amount of turning operation between the left and right travel levers.

The larger the difference between the left and right travel levers, the smaller the radius of the turn will be.

[Turning while increasing speed]

(At forward traveling)

- To make a gradual turn at forward traveling, push the travel lever forward a small amount on the opposite side of the direction to turn.
To make a rapid turn at forward traveling, push the travel lever forward a large amount on the opposite side of the direction to turn.
- To make a left turn, push the right travel lever forward. To make a right turn, push the left travel lever forward.

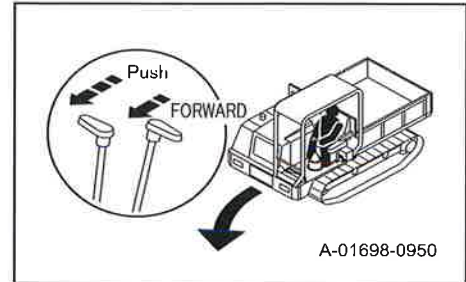

(At reverse traveling)

- To make a gradual turn at reverse traveling, pull the travel lever back a small amount on the opposite side of the direction to turn.
To make a rapid turn at reverse traveling, pull the travel lever back a large amount on the opposite side of the direction to turn.
- To make a left turn, pull the right travel lever back. To make a right turn, pull the left travel lever back.

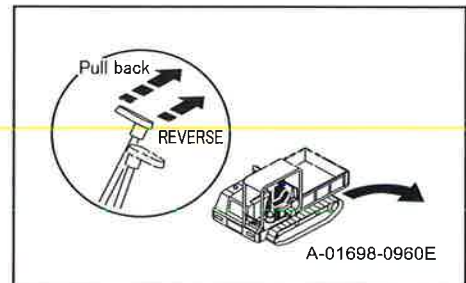

[Turning while decreasing speed]

(At forward traveling)

- To make a gradual turn at forward traveling, pull the travel lever back a small amount toward the N (neutral) position on the same side of the direction to turn.
To make a rapid turn at forward traveling, pull the travel lever back a large amount toward the N (neutral) position on the same side of the direction to turn.
- To make a left turn, pull the left travel lever back toward the N (neutral) position. To make a right turn, pull the right travel lever back toward the N (neutral) position.

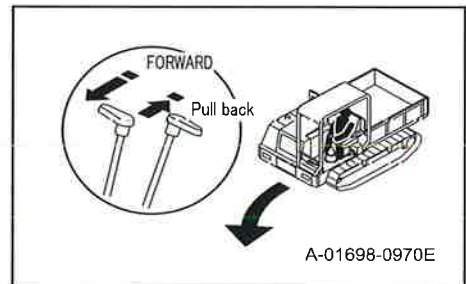

(At reverse traveling)

- To make a gradual turn at reverse traveling, push the travel lever a small amount toward the N (neutral) position on the same side of the direction to turn.
To make a rapid turn at reverse traveling, push the travel lever a large amount toward the N (neutral) position on the same side of the direction to turn.
- To make a left turn, push the left travel lever toward the N (neutral) position. To make a right turn, push the right travel lever toward the N (neutral) position.

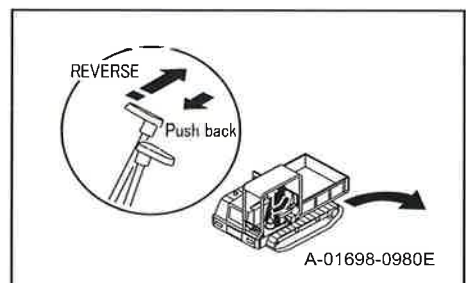



★ When the undercarriage structure direction is reversed (the sprocket is at the front side), operate the machine as follows.

[1] GRADUAL AND RAPID TURN

The radius of the turn is determined by the difference in the amount that the left and right travel levers are operated.

The larger the difference between the left and right travel levers, the smaller the radius of the turn will be.

**[Turning while increasing speed]
(At forward traveling)**

- To make a gradual turn at forward traveling, pull the travel lever back a small amount on the same side of the direction to turn. To make a rapid turn at forward traveling, pull the travel lever back a large amount on the same side of the direction to turn.
- To make a left turn, pull the left travel lever back. To make a right turn, pull the right travel lever back.

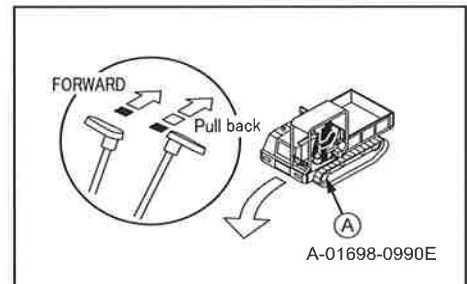

(At reverse traveling)

- To make a gradual turn at reverse traveling, push the travel lever a small amount on the same side of the direction to turn. To make a rapid turn, push the travel lever a large amount on the same side of the direction to turn.
- To make a left turn, push the left travel lever forward. To make a right turn, push the right travel lever forward.

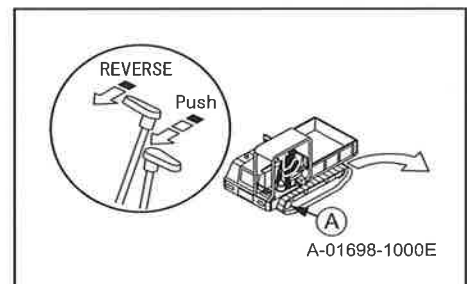

**[Turning while decreasing speed]
(At forward traveling)**

- To make a gradual turn at forward traveling, push the travel lever a small amount toward the N (neutral) position on the opposite side of the direction to turn. To make a rapid turn, push the travel lever a small amount toward the N (neutral) position on the opposite side of the direction to turn.
- To make a left turn, push the right travel lever toward the N (neutral) position. To make a right turn, push the left travel lever toward the N (neutral) position.

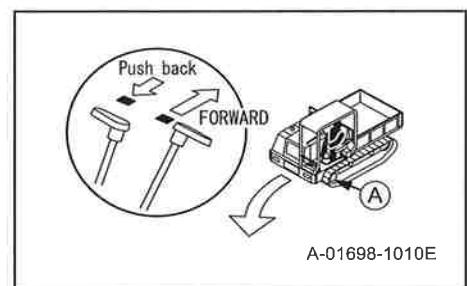

(At reverse traveling)

- To make a gradual turn at reverse traveling, push the travel lever a small amount toward the N (neutral) position on the opposite side of the direction to turn. To make a rapid turn, push the travel lever a large amount toward the N (neutral) position on the opposite side of the direction to turn.
- To make a left turn, push the right travel lever toward the N (neutral) position. To make a right turn, push the left travel lever back toward the N (neutral) position.

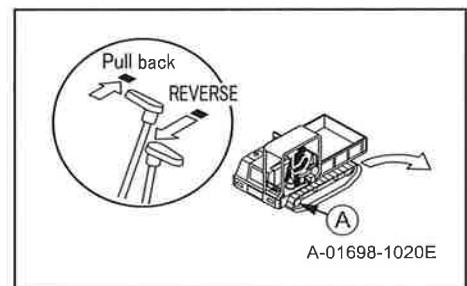



[2] PIVOT TURN

Operate the travel lever on one side and set the other lever at the the N (neutral) position. Only the crawler on the side that is operated will rotate, so the machine will make a pivot turn.

- To make a left turn at forward traveling, push the right travel lever forward. To make a right turn at forward traveling, push the left travel lever forward.
- To make a left turn at reverse traveling, pull the right travel lever back. To make a right turn, pull the left travel lever back.

★ When the undercarriage structure direction is reversed (the sprocket is at the front side), operate the machine as follows.

- To make a left turn at forward traveling, pull the left travel lever back. To make a right turn at forward traveling, pull the right travel lever back.
- To make a left turn at reverse traveling, push the left travel lever forward. To make a right turn at forward traveling, push the left travel lever forward.

[3] SPIN TURN

Operate the left and right travel levers in opposite directions. The left and right crawlers will rotate in opposite directions and the machine will make a spin turn.

- To make a left turn, push the right travel lever forward and pull the left travel lever back.
- To make a right turn, push the left travel lever forward and pull the left travel lever back.
- ★ When the undercarriage structure direction is reversed (the sprocket is at the front side), the machine travels in the same direction of the lever operation.

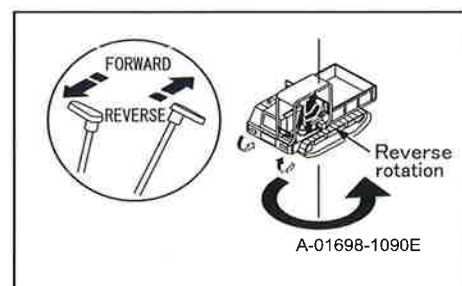
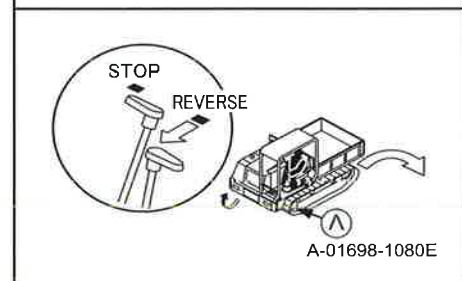
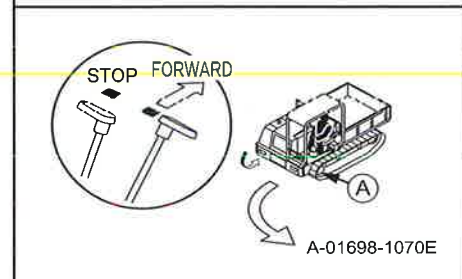
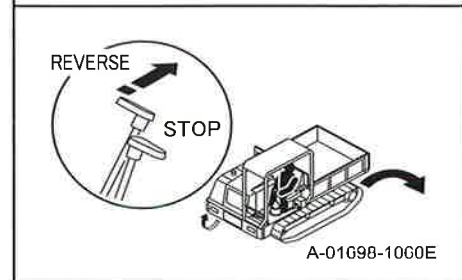
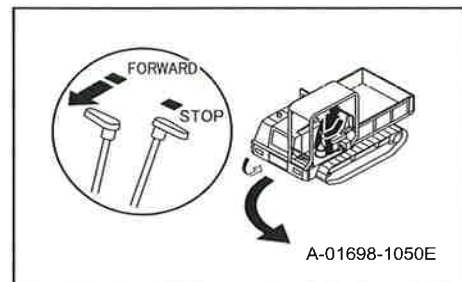

3.7 STOPPING MACHINE

WARNING

- Ensure that the forward center pilot lamp (green) lights up. When the forward center pilot lamp (green) lights up, the revolving upper structure and undercarriage structure are facing right in front. Also, the revolving upper structure and undercarriage structure are mutually in parallel.
- Ensure the moving direction of the undercarriage structure before operating the travel lever. When the undercarriage structure direction is reversed (the sprocket is at the front side), the machine travels in the opposite direction of the lever operation and turning direction also reverses.
- Avoid stopping suddenly. Always leave extra room when stopping.
- If a dangerous state occurs by any possibility, and when it becomes necessary to stop the machine urgently, turn starting switch to the OFF position to stop the engine. This applies the parking brake and the machine is stopped quickly.
- When stopping the machine, return the left and right travel levers to the N (neutral) position at the same time. If the left and right levers are not operated at the same time, there is danger that the brakes will pull to one side.
- When stopping, do not return the travel lever past the N (neutral) position. If the lever is moved past the N (neutral) position, it will cause such as reverse rotation of the engine.

Return the left and right travel levers to the N (neutral) position.

The hydraulic brakes are automatically applied and the machine stops.

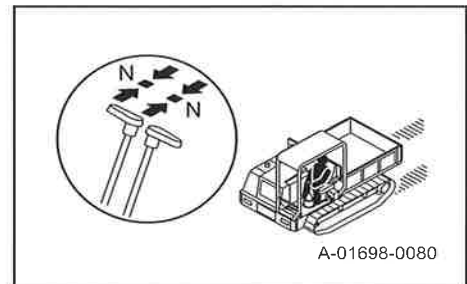

3.8 EMERGENCY STOP

WARNING

If a dangerous situation occurs and it becomes necessary to stop the machine immediately, turn the starting switch to the OFF position to stop the engine.

The following are 2 methods to make an emergency stop of the machine.

- Return the left and right travel levers to the N (neutral) position.
- Turn the starting switch key back to the OFF position to stop the engine.

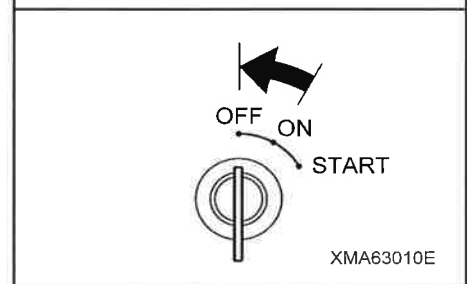
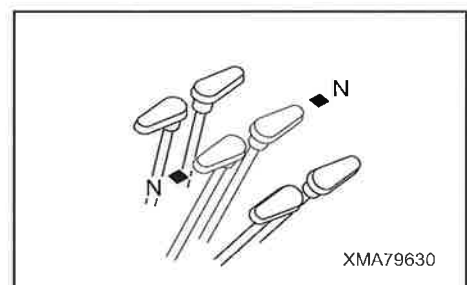

3.9 SWINGING REVOLVING UPPER STRUCTURE

! WARNING

- Always park the machine on a level surface before swinging the revolving upper structure.
- When swinging the machine from higher to lower direction on a slope, swing speed of the revolving upper structure increases due to gravity.
- When there are persons or obstacles in the area around the machine, always position a signalman and follow the signals to swing the revolving upper structure.
- Always operate the swing control lever slowly. Never attempt to swing the loaded revolving upper structure in high speed or rapidly stop swinging. Failure to do so may cause a failure and impair the safety in the surrounding area.

Follow the procedure below to swing the revolving upper structure.

1. Turn the engine throttle lever to the mid-range speed position.

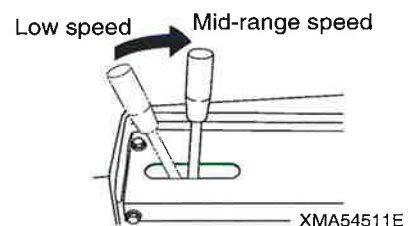

2. Set the swing lock switch on the control panel to the OPEN (release) position.

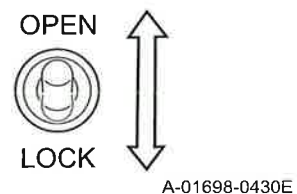

3. Always operate the swing control lever slowly.

- LEFT TURN: The revolving upper structure swings leftward (counterclockwise).
- HOLD: The dump body is stopped and held in position.
- RIGHT TURN: The revolving upper structure swings rightward (clockwise).

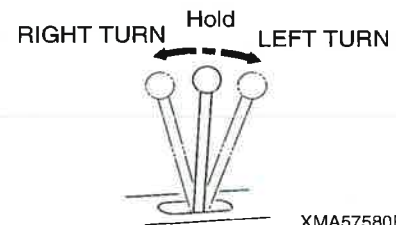

★ When the control lever is released, it automatically returns to the HOLD position.

★ The figure on the right shows the machine with revolving upper structure (1) and undercarriage structure (2) facing in the opposite direction. In this condition, the forward center pilot lamp (green) goes out. Since sprocket (A) of undercarriage structure (2) is located forward when viewed from the operator's seat, the operating directions of the travel lever and pedal are opposite to the forward/reverse directions and turning directions (left turn and right turn) of the machine.

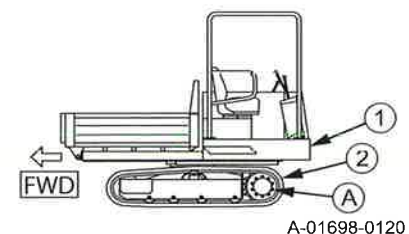

Example: If the travel lever is operated forward, the machine moves in rear when viewed from the operator's seat.

4. After swinging the machine, set the swing lock switch to the LOCK position.

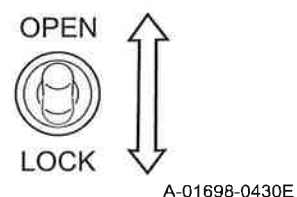



3.10 PARKING

WARNING

Choose firm, level ground to park the machine. If the machine must be parked on a slope, apply the parking brake and block the rubber crawlers to prevent the machine from moving.

Return the left and right travel levers to the N (neutral) position.

The parking brake is automatically applied.

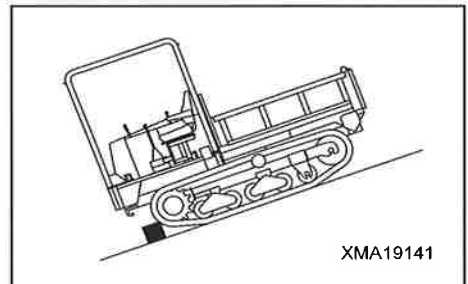
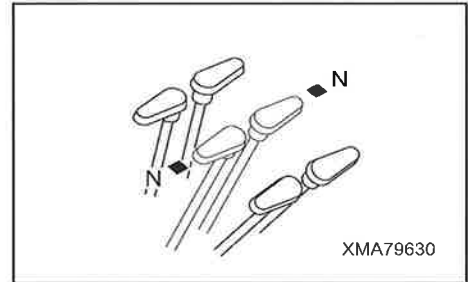

3.11 STOPPING ENGINE

NOTICE

- Do not stop the engine before it has properly cooled down. Stopping the machine before it cools down shortens the service life of the engine. Never stop the engine suddenly except in cases of emergency.
- If the engine has overheated, do not stop it suddenly. Run the engine at a mid-range speed and gradually cool it down before stopping the engine.

1. Push the throttle lever forward, set the engine to low speed, and run the engine at idling for 5 minutes to cool the engine down.

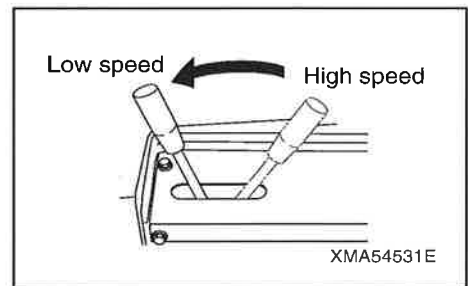

2. Set the starting switch key back to the OFF position. The engine stops.

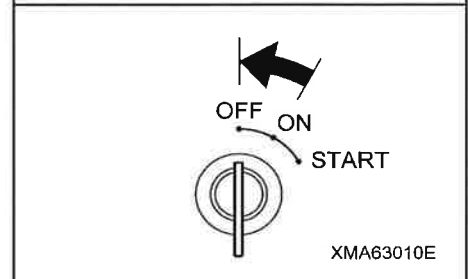



3.12 LEAVING OPERATOR'S SEAT

When leaving the operator's seat after operation, do as follows.

1. Before leaving the operator's seat, ensure that the travel lever, swing control lever, and dump control lever are in the N (neutral) position. Set safety lock lever (1) to the LOCK position.
2. Safety lock lever (1) lowers and it facilitates the operator to get out of the operator's seat.
3. Always take the starting switch key with you.

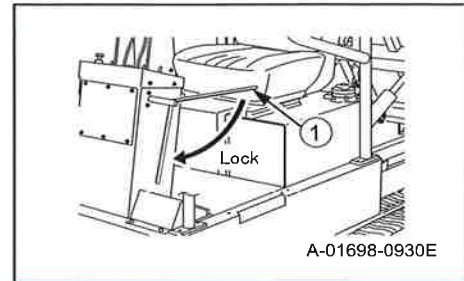

3.13 CHECKS AFTER STOPPING ENGINE

- Carry out walk-around checks to check the undercarriage, dump body, and bodywork; check also for oil and water leaks. If any abnormality is found, repair it.
- Fill up the fuel tank with fuel.
- Dead leaves, waste paper, or other flammable items around the engine may cause a fire. Remove if any.
- Remove any mud or snow stuck to the undercarriage or dump body.

3.14 LOCKING

To prevent vandalism, the following locations can be locked.

(1) Fuel tank filler cap

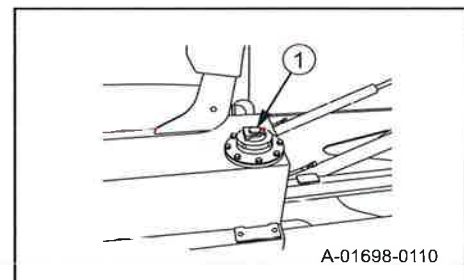

(2) Engine cover

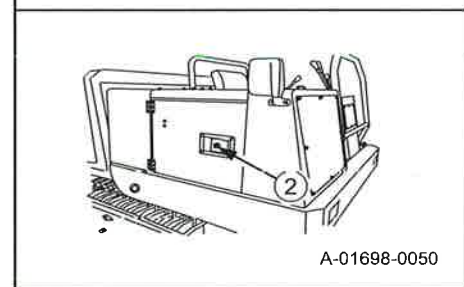



3.15 PRECAUTIONS WHEN TRAVELING

WARNING

Always follow these precautions when traveling. Failure to do so may lead to a serious injury or accident.

[1] PERMISSIBLE WATER DEPTH

When operating in water, do not let the bottom surface of the track frame go below the water surface.

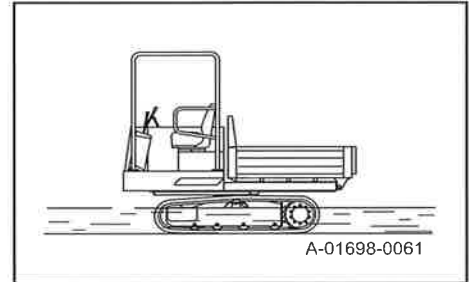

[2] PRECAUTIONS WHEN ENGINE STOPS ON SLOPES

If the engine stops on a slope, do as follows.

1. Return the travel levers to the N (neutral) position.
2. Start the engine again.

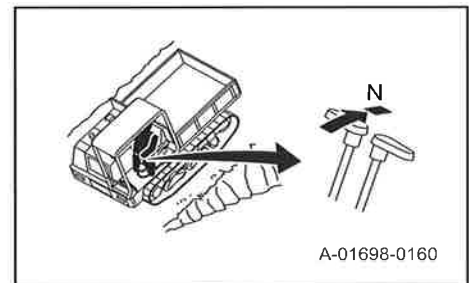

[3] PRECAUTIONS WITH FUEL LEVEL ON SLOPES

If the fuel level in the fuel tank is low and the machine is on a slope or there is swaying, the engine may suck in air, which may cause the engine to stop.

Always maintain a sufficient level of fuel in the fuel tank.

[4] PRECAUTIONS FOR OIL LEVELS ON SLOPES

When traveling or carrying out operations on steep slopes, check the oil level in the hydraulic tank and engine, and add oil to the high level.

This prevents failure caused by lack of oil.

[5] PRECAUTIONS FOR FORWARD CENTER PILOT LAMP

After swing operations, be sure to check whether the forward center pilot lamp (green) lights up.

When the forward center pilot lamp goes out, the revolving upper structure is not positioned parallel to the undercarriage structure. If they are not positioned parallel to each other, the machine causes a large travel deviation even if you are driving the machine straight ahead.

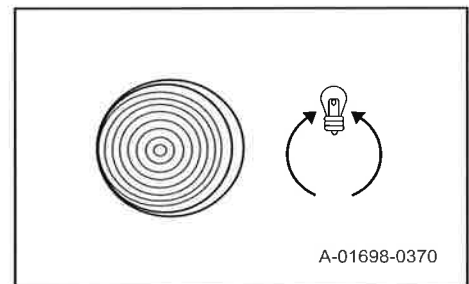

4. HANDLING DUMP BODY

4.1 OPERATING DUMP BODY

WARNING

- Always stop the machine on a level surface before operating the dump body to the dumping position.
- Position a signalman to ensure safety in the surrounding area, and follow his signals when carrying out the dumping operation.
- Always operate the dump control lever slowly. If the dump body is suddenly stopped or it is allowed to hit the frame when it is lowered, it may cause a failure and compromise the safety in the surrounding area.
- When leaving the operator's compartment with the dump body raised, always stop the engine. And then, set the safety lock lever to the LOCK position. In addition, use the safety bar to prevent the dump body from coming down. Even when the engine is stopped, it is possible to lower the dump body.

Operate the dump body as follows.

★The further the dump control lever is operated, the faster the dump body moves. When the dump control lever is released, it automatically returns to the HOLD position.

1. Stop the machine completely. For details, see "3.7 STOPPING MACHINE in OPERATION".
2. Pull the throttle lever back and raise the engine speed sufficiently.
3. Pull the dump control lever back. The dump body rises.
 - ★When the dump body comes near the max. height, push the dump control lever to the HOLD direction to reduce the speed of the dump body.
4. Push the dump control lever forward. The dump body goes down.
 - ★When the dump body comes near the frame, pull the dump control lever to the HOLD direction to reduce the speed of the dump body.

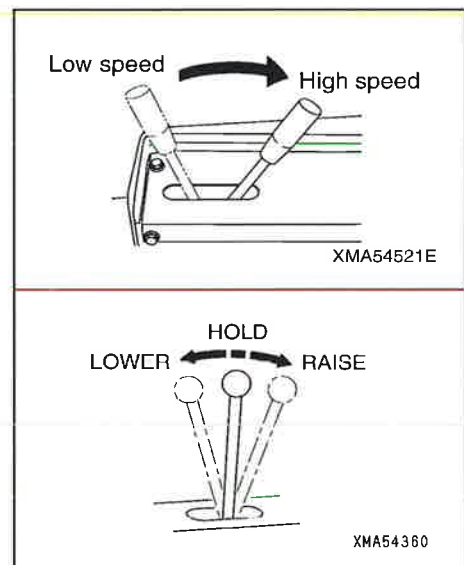

4.2 OPERATING SAFETY BAR

WARNING

- If it is necessary to go under the dump body to carry out inspections and maintenance, always use the safety bar to prevent the dump body from coming down.
- When using the safety bar, check that the bar is fitted securely to the dump body holder.
- The safety bar is a safety device used during inspections and maintenance.
Do not use the safety bar to support the dump body when replacing equipment that holds the dump body such as the dump cylinder, valve, and hydraulic hoses. In such cases, always support the dump body with a crane.

NOTICE

Do not set the safety bar in position with the engine running and the dump control lever in the LOWER position. Doing so may cause the safety bar to hit the dump body, resulting in damage.
When the work is done, be sure to return the safety bar to its original position and lower the dump body.

[1] SETTING SAFETY BAR

1. Fully raise the dump body (60 degrees). See "4.1 OPERATING DUMP BODY in OPERATION".
2. Raise safety bar (1) and set it in holder (2) at the bottom of the dump body.
3. Stop the engine and push the dump control lever forward. The dump body goes down by its own weight.
 - ★ If the dump body does not go down by its own weight, start the engine and operate the dump control lever forward to a point where the dump body and safety bar still do not come into contact.

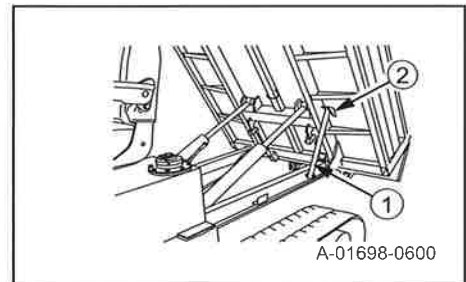

[2] STORING SAFETY BAR

1. Raise the dump body fully. For details, see "4.1 OPERATING DUMP BODY in OPERATION".
2. Return safety bar (1) to the specified position on top of the frame.

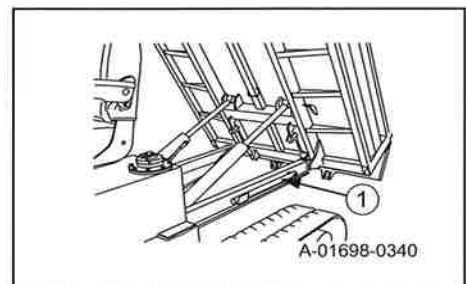



4.3 PRECAUTIONS DURING OPERATION

WARNING

Always follow these precautions when carrying out operations. Failure to do so may lead to a serious injury or accident.

[1] PRECAUTIONS FOR JOBSITES

- As much as possible, select firm, level ground.
When working on slopes or extremely uneven ground, the change in the center of gravity when the dump is operated may cause the machine to tip over.
- As much as possible, avoid the edge of cliffs or ground which may collapse.
If work must be carried out in such places, set up blocks to prevent the machine from going near the edge or near retaining walls, or position a signalman and take other necessary steps for ensuring safety.
- When dumping a load from a high point, always position a signalman and follow the signals. The signalman must always check the safety of the dumping point carefully.
- When carrying out dumping operations after swinging the revolving upper structure, be careful of the following.
 - When the revolving upper structure and undercarriage structure are facing in the opposite direction, the operating directions of the travel lever and pedal are opposite to the forward/reverse directions of the machine.
The operating direction of the travel lever and pedal may need to be changed depending on the direction of the revolving upper structure. Failure to do so can cause the machine to fall or hit other obstacles.
- When dump operation with the revolving upper structure swung 90 deg. is unavoidable, check the condition of unloading place and secure sufficient distance between the machine, unloading place and the road shoulder beforehand.
Swing the revolving upper structure after the machine is in the unloading position. After unloading, lower the dump body, swing the revolving upper structure to the original position, and then move the machine.
- When dumping on a slope with the revolving upper structure swung 90 deg., the machine tip-over risk increases. If you feel that the machine is not stable, stop the operation immediately.

[2] PRECAUTIONS FOR LOAD

- Do not overload the machine.
Do not add side racks or plates, or make other modifications to extend the size of the dump body to increase the load.
- When loading the dump body, always spread the load to maintain the balance in the dump body. Loading the dump body unevenly causes instability and may cause the machine to tip over.
- Be careful not to let the loading bucket or crane hook hit the dump body or flaps.
- When loading large rocks, first load the dump body with fine soil, then load the rocks on top.
- When handling long objects, such as logs or steel beams, load carefully and pay careful consideration to the center of gravity so that the load does not collapse or sway excessively during hauling operations. Tie down such loads securely with rope. If necessary, use blocks and take steps to prevent the rope from slipping.
- When loading stacks of U-shaped ditch liners or concrete blocks, lay a steel sheet and secure with rope, and take other steps to prevent the load from slipping.

5. HANDLING RUBBER CRAWLER

5.1 FEATURES OF RUBBER CRAWLER

The properties of the material used for the rubber crawlers give it many advantages, such as low vibration, high drawbar pull, and ease of handling.

Make sure that you fully understand the advantages of rubber crawlers, and follow the content of “5.2 PROHIBITED OPERATIONS FOR RUBBER CRAWLER” and “5.3 PRECAUTIONS WHEN USING RUBBER CRAWLER” to extend the service life of the rubber crawlers and to realize the maximum advantages of the rubber crawler.

5.2 PROHIBITED OPERATIONS FOR RUBBER CRAWLER

- Turning operations or other operations on ground with crushed stones, extremely uneven hard ground, in places with many tree stumps, on steel rods or steel scrap, or places with many sharp objects, or on concrete surfaces can cause damage to the rubber crawlers.
- On riverbeds or other jobsites where there are large numbers of rocks of different sizes, the rocks will get caught in the rubber crawlers and damage the crawler or cause it to come off the roller.
- Do not let oil, fuel, or chemical solvent get on the rubber crawlers. Do not travel in places where those substances are present.
- Do not let the machine enter any place where the ground is at high temperature, such as on asphalt or steel plates that have been left in the sun or in places where there have been fires.
- When putting the machine in long-term storage (3 months or more), store the machine indoors where it is out of direct sunlight and rain.

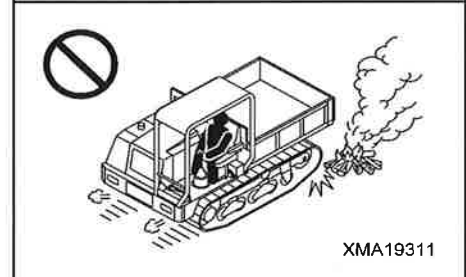
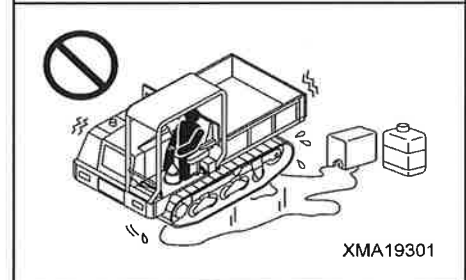
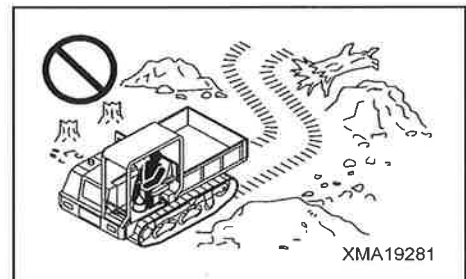

5.3 PRECAUTIONS WHEN USING RUBBER CRAWLER

WARNING

Always follow these precautions when using rubber crawlers. Failure to do so may lead to a serious injury or accident.

- Do not make sharp turns on concrete surfaces.
- Do not operate the machine in such a way that the rubber crawlers scrapes against concrete walls.
- Sudden changes of direction can cause damage and premature wear to the rubber crawlers, so avoid sudden turns as much as possible.
- Avoid traveling and turning in places where there is a large ridge.
When traveling over a ridge, approach the ridge at a right angle.
- As much as possible, avoid handling loads that produce oil when crushed (soy beans, corn, vegetables, etc.). If the machine is used for handling such products, be sure to wash the rubber crawlers thoroughly after use.
- When handling loads such as salt, ammonium sulphate, potassium chloride, potassium sulphate, or phosphates, be sure to wash the rubber crawlers thoroughly after use.
- On snow or frozen road surfaces, the rubber crawler slips very easily.
Be careful of slipping especially when traveling or operating on slopes.
- To prevent the rubber crawler from coming off, always check that the tension is correct.
If the tension is too loose, the rubber crawler may come off and it can cause abnormal wear on the steel core and sprocket.
If the tension is too tight, it can reduce the travel speed and cause premature wear or damage to the undercarriage.

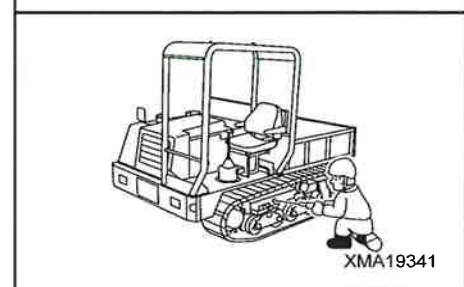
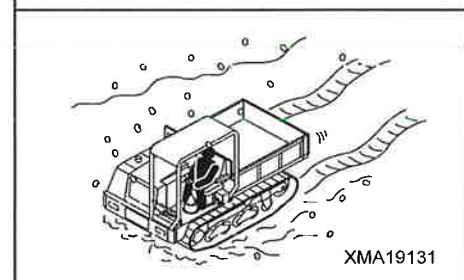
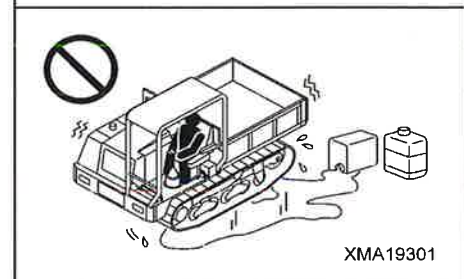
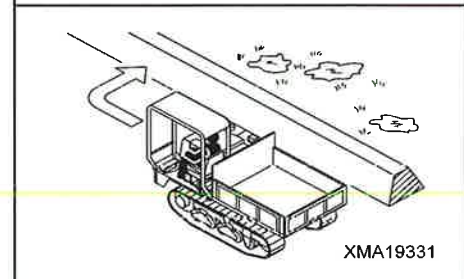
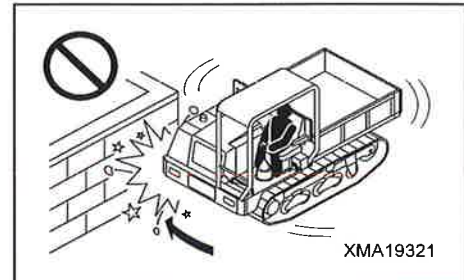

6. TRANSPORTATION

6.1 LOADING, UNLOADING WORK

WARNING

- Make sure the ramp has sufficient width, length and thickness that allows the machine to be safely loaded and unloaded. If the ramp sags appreciably, reinforce it with blocks, etc.
- When loading and unloading the machine, park the trailer on a flat firm ground. Keep a fairly long distance between the road shoulder and the machine.
- Remove the mud or snow from the undercarriage to prevent the machine from slipping to the side on slopes. Make sure that the ramp surface is clean and free of oil, grease, ice, and other loose materials.
- Never change the direction of travel when on the ramps. If it is necessary to change the direction, drive off the ramps and correct the direction, then drive onto the ramps again.

When loading or unloading, always use ramps or a platform and carry out the operations as follows.

1. Apply the brake securely to the hauler or trailer and put blocks under the tires to prevent the machine from moving.
2. Set the ramps so that the center of the machine is aligned with the hauler or trailer, and fix securely in position.
 - ★ Check that the left and right ramps are at the same height.
3. Align the machine with the ramps, and drive up or down the ramps slowly to the load or unload the machine.
4. To prevent the machine from moving during transportation, put wooden blocks under the front and rear of the rubber crawler and secure the machine with chains or wire rope. Fasten securely so that it does not slip to the side.
5. Fold the side mirror.
6. Ensure that the dump body is completely lowered.

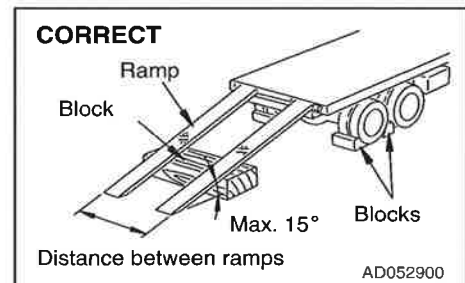

6.2 PRECAUTIONS FOR LOADING

WARNING

When loading and unloading the machine, park the trailer on a flat firm ground. Keep a fairly long distance between the road shoulder and the machine.

After loading the specified position, secure the machine as follows.

1. Lower the dump body slowly.
2. Return the engine throttle lever to the low-speed position, turn the starting switch to the OFF position and stop the engine. Remove the starting key.
3. When transporting the machine, place rectangular timber underneath the front and rear rubber crawlers to prevent the machine from moving about. Also, hold it down with chains or rope. Be particularly careful to ensure that the machine does not slip sideways.

6.3 PRECAUTIONS FOR TRANSPORTATION

WARNING

Determine the route for transporting the machine by taking into account the width, height and weight of the machine.

Obey all state and local laws governing the weight, width and length of a load. Further, observe all laws and regulations concerning the gas, liquid and solid consisting the machine such as pressurized gas, fuel, grease, fluid and other materials.



7. COLD WEATHER OPERATION

7.1 PRECAUTIONS FOR LOW TEMPERATURE

If the temperature becomes low, it becomes difficult to start the engine, and the coolant may freeze, so do as follows.

[1] FUEL AND LUBRICANTS

Change to fuel and oil with low viscosity for all components.

For details, see "3. USE OF FUEL, COOLANT AND LUBRICANTS ACCORDING TO AMBIENT TEMPERATURE in MAINTENACE".

[2] COOLANT MIXTURE RATIO IN COOLING WATER

WARNING

The coolant is flammable, so never put it close to a fire.

NOTICE

Never use coolant with methanol, ethanol, or propanol bases.

Use a mixture of long-life coolant and tap water as the coolant to prevent overheating, rust, corrosion, and freezing of the cooling system.

The coolant has rust prevention, anti-corrosion, and antifreeze properties, so it can be used throughout the year.

Strictly observe the coolant mixing rate of 50% to allow it to maintain rust prevention and anti-corrosion properties.

At factory shipment, this machine contains coolant with the following long-life coolant at a mixing rate of 50 %.

★ KOGA Chemical Mfg Co.,Ltd. Brand LLC (Green): Non-amine type (Long-life coolant)



[3] BATTERY

⚠ WARNING

- To avoid gas explosions, do not bring fire or sparks near the battery.
- Battery electrolyte is dangerous. If it gets in your eyes or on your skin, wash it off with large amounts of water, and consult a doctor.

The performance of the battery drops at low temperatures.

If the battery charge ratio is low, the battery electrolyte may freeze. Maintain the battery charge as close as possible to 100%, and insulate it against cold temperature so that the machine can be started easily the next morning.

When adding distilled water, to prevent the electrolyte from freezing, always add the distilled water immediately before starting operations on the following morning.

Measure the specific gravity of the battery electrolyte and calculate the rate of charge from the following conversion table.

Rated of charge (%)	Temp. of battery electrolyte				
	°C	20	0	-10	-20
	°F	68	32	14	-4
100		1.28	1.29	1.30	1.31
90		1.26	1.27	1.28	1.29
80		1.24	1.25	1.26	1.27
70		1.23	1.24	1.25	1.26

7.2 AFTER COMPLETION OF WORK

To prevent the undercarriage and dump body from freezing due to mud, water, or snow on them and becoming inoperable the next morning, always observe the following precautions.

- Mud, water, or snow on the machine body, dump body and undercarriage should be completely removed.
- In particular, thoroughly wipe off the hydraulic cylinder rod surface on the dump body. This is to prevent damage to the seal caused by mud or dirt getting inside the seal with frozen drops of water.
- The machine should be housed in a dry building. Never leave it outdoors.
If it is unavoidable to leave it outdoors, park the machine on the firm, flat ground and place wooden blocks underneath the machine. Doing so prevents the surface of the ground touching the undercarriage from freezing, making it easier to start the machine the next morning.
- Remove the drain plug on the fuel tank and drain any water collected in the fuel tank to prevent it from freezing.
- As the battery capacity drops markedly in low temperatures, cover the battery or remove it from the machine, keep it in a warm place, and install it again the next morning.

7.3 AFTER COLD WEATHER

When the season changes and the weather becomes warmer, do as follows.

- Replace the oil and fuel for all parts with high viscosity oil or fuel.
For details, see “3. USE OF FUEL, COOLANT AND LUBRICANTS ACCORDING TO AMBIENT TEMPERATURE in MAINTENACE”.
- Drain the coolant completely from the cooling system and clean the inside of the cooling system thoroughly.



8. LONG-TERM STORAGE

8.1 PRECAUTIONS BEFORE STORAGE

When putting the machine in storage for more than one month, do as follows.

- The machine should be housed in a dry building. Never leave it outdoors. If it is unavoidable to leave it outdoors, park the machine on the firm, flat ground and place wooden blocks underneath the machine. Also, cover it completely with canvas, etc.
- After cleaning and lubricating every part, completely fill the fuel tank, apply grease, and change the oil before storage.
- Apply a sufficient amount of grease to the exposed parts such as piston rods and shafts of the hydraulic cylinders.
- Disconnect the negative terminals of the battery and cover it, or remove it from the machine and store it separately.
- If the temperature goes below 0 deg. C (32 deg. F), add anti-freeze to the coolant. When not using anti-freeze, drain all the coolant, and put a "No coolant" sign in the operator's compartment.

8.2 PRECAUTIONS DURING STORAGE

WARNING

If warming-up operation must be carried out inside a building, open the windows and doors to ensure good ventilation to prevent carbon monoxide poisoning.

- When the machine is in long-term storage, start the engine once a month and carry out a thorough warming-up operation. In addition, move the machine for a short distance, and carry out the raise and lower operations sufficiently for the dump body.
- ★ If the cooling water has been drained from the machine, always fill with cooling water before starting the engine.
- ★ Before operating the dump body, wipe off the coat of grease from the piston rods of the hydraulic cylinders.

8.3 PRECAUTIONS AFTER STORAGE

Carry out the following procedure when using the machine after long-term storage.

- If the coolant was removed from the machine, be sure to refill with coolant.
- Wipe off the coat of grease from the piston rods of the hydraulic cylinders.
- Remove the drain plugs from the hydraulic tank, fuel tank, engine oil pan, and travel motors, and drain the water.
- Drain the water from the engine oil filter, fuel filter, and hydraulic oil line filter.
- Carry out checks before starting and warm up the machine thoroughly, then carefully check all parts of the machine.

9. HANDLING BATTERY

When handling the battery, always do as follows.

⚠ DANGER

- Before working with the battery, stop the engine and turn the key in the starting switch to the OFF position.
- When working with the battery, always wear safety glasses.
- Batteries generate hydrogen gas and can explode. Do not smoke, use a lighter, or create any spark near the battery.
- Battery electrolyte contains sulphuric acid. If you get acid on yourself, immediately flush the area with large amounts of water. If acid gets into your eyes, flush them immediately with large amounts of fresh water, then see a doctor for treatment.
- When removing the battery, first disconnect the negative (-) terminal of the cable from the ground. When installing, install the positive (+) terminal first.
- If any tool touches between the battery positive (+) terminal and the chassis, sparks may occur. It is dangerous. Do not put tools and other metal objects in your breast pocket. They may fall out.
- Contact failure caused by loose battery terminals can generate sparks and lead to an explosion. Tighten the battery terminals securely.

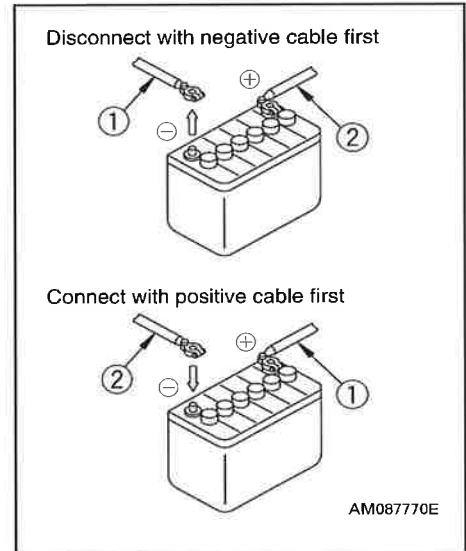

9.1 PRECAUTIONS WHEN HANDLING BATTERY

- Always be careful not to let the battery become discharged. Do not wait for the battery to become discharged before recharging it; measure the specific gravity of the battery electrolyte beforehand and charge the battery if necessary. Always keep the battery in good condition to extend the life of the battery.
- When operating the machine in high temperatures, check the level of the battery electrolyte at shorter intervals than specified for periodic inspections and maintenance.
- The performance of the battery significantly drops at low temperatures. Maintain the battery charge as close as possible to 100% and insulate it against cold temperatures so that the machine can be started easily the next morning. When adding distilled water, to prevent the electrolyte from freezing, always add the distilled water immediately before starting operations on the following morning.



9.2 REMOVAL AND INSTALLATION OF BATTERY

The battery is installed into the battery inspection cover the front right side of the machine.

[1] REMOVAL

1. Open the battery inspection cover.
2. Disconnect the battery cable from the negative (-) terminal (3) contacted to the ground, then disconnect the positive (+) terminal end (4).
3. Remove battery (5).

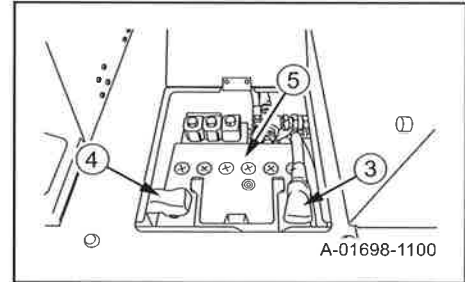

[2] INSTALLATION

Install the batteries in the reverse order of removal.

- ★When connecting the battery cables, always install the negative (-) terminal at the ground end (3) last.

9.3 PRECAUTIONS WHEN CHARGING BATTERY

If the battery becomes discharged or the battery charge is low, charge the battery.

To charge the battery when it is still mounted on the machine, do as follows.

WARNING

It is dangerous if the temperature of the battery electrolyte exceeds 45 deg. C (113 deg. F) during charging, so stop charging and wait for the temperature to cool down.

- Disconnect the wiring from the battery terminals before charging. Abnormal voltage may be applied to the alternator, causing damage to the alternator. When disconnecting the wiring, always disconnect the negative (-) terminal wiring first; and when connecting the wiring, always connect the negative (-) terminal wiring last.
- During charging, remove all the plugs from the battery cells to allow any gas to escape.
- When the charging is completed, stop the charging immediately. If the battery is overcharged, overheating of the battery causes damage to the battery.

- ★Reference: Measure the specific gravity and calculate the rate of charge from the following conversion table.

Rated of charge (%)	Temp. of battery electrolyte				
	°C	20	0	-10	-20
	°F	68	32	14	-4
100		1.28	1.29	1.30	1.31
90		1.26	1.27	1.28	1.29
80		1.24	1.25	1.26	1.27
70		1.23	1.24	1.25	1.26

9.4 STARTING ENGINE WITH BOOSTER CABLES

If the battery is discharged and booster cables are used to start the engine, do as follows.

⚠ DANGER

- Be careful not to let the normal machine and problem machine contact each other.
- When connecting the booster cables, never let the positive (+) and negative (-) terminals contact each other.
- Make sure that booster cables are connected correctly. Because sparks are generated when the last negative (-) terminal is connected, do not connect to the negative (-) terminal of the battery on the problem machine. Connect to the engine block.
- When starting the engine with booster cables, always wear safety glasses.

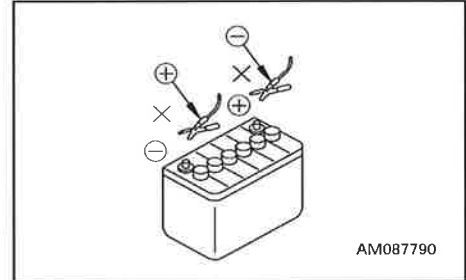

NOTICE

- The size of the booster cables and clip should be suitable for the battery capacity. Check that they are not corroded or damaged.
- The battery on the normal machine must be the same capacity as that on the problem machine.

[1] CONNECTING BOOSTER CABLES

★ The numbers in the diagram on the right show the order for connecting the cables.

1. Make sure that the starting switches of the normal machine and problem machine are both in the OFF position.
2. Connect the clips at the ends of booster cable A to the positive (+) terminals of the problem machine and the normal machine.
3. Connect one clip of booster cable B to the negative (-) terminal of the normal machine.
4. Connect the other clip of booster cable B to the engine block of the problem machine.
5. Start the problem machine.

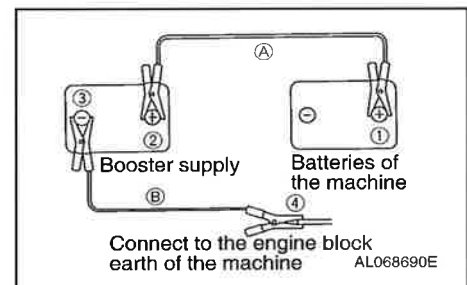

[2] DISCONNECTING BOOSTER CABLES

★ The numbers in the diagram on the right show the order for disconnecting the cables.

When the engine on the problem machine starts, remove the cables in the reverse order of connecting.

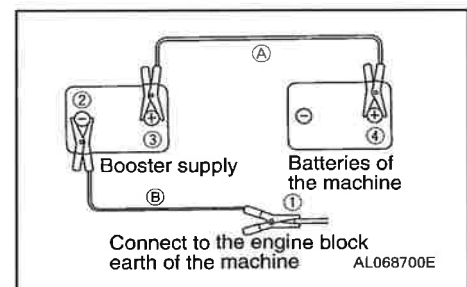



10. TROUBLESHOOTING

If any abnormality is felt, investigate the cause immediately and take the necessary action to prevent any serious failure.

If the cause is unknown, please contact your distributor for repairs.

When contacting your distributor, please give the machine serial number and engine number.

10.1 PROBLEMS WITH ENGINE RELATED PARTS

Problem	Main causes	Remedy
Starting motor does not turn when starting switch is turned to START	<ul style="list-style-type: none"> • Battery charge is too low • Defective wiring • Failure in starting motor or relay 	<ul style="list-style-type: none"> • Charge • Check and repair if necessary • Contact your distributor
Starting motor turns, but cranks engine slowly	<ul style="list-style-type: none"> • Battery charge is too low • Defective ground connection wiring • Viscosity of engine oil is too high 	<ul style="list-style-type: none"> • Charge • Check and repair if necessary • Change to proper viscosity
Starting motor turns, but engine does not start	<ul style="list-style-type: none"> • Insufficient fuel • Air in fuel system • Failure in fuel injection pump • Failure in engine 	<ul style="list-style-type: none"> • Check and add fuel • Bleed air • Contact your distributor • Contact your distributor
After the warming-up operation, "engine oil pressure warning lamp" on the instrument panel lights up even when engine speed is raised. (Engine oil pressure does not rise.)	<ul style="list-style-type: none"> • Insufficient engine oil • Clogged engine oil filter • Failure in engine parts 	<ul style="list-style-type: none"> • Check and add fuel • Replace with a new one • Contact your distributor
The engine water temperature warning lamp lights up. or steam spurts out from near the radiator system	<ul style="list-style-type: none"> • Low coolant level • Leakage of coolant from cooling system • Loose fan belt • Clogged radiator fin • Faulty thermostat • Overloading, operation under excessive load 	<ul style="list-style-type: none"> • Check and add water • Check and repair if necessary, or contact your distributor • Check and adjust if necessary, or replace with a new fan belt • Check and clean • Replace with a new one • Reduce the load below the payload
Engine exhaust color is white	<ul style="list-style-type: none"> • Engine oil level is too high • Improper fuel 	<ul style="list-style-type: none"> • Adjust to correct amount • Change to specified fuel
Engine exhaust color is black	<ul style="list-style-type: none"> • Clogged air cleaner • Improper fuel • Failure in engine 	<ul style="list-style-type: none"> • Check and clean • Change to specified fuel • Contact your distributor
Engine does not run smoothly	<ul style="list-style-type: none"> • Air in fuel system • Fuel filter clogged with dirt, water in fuel filter • Leakage of fuel from fuel system • Failure in engine 	<ul style="list-style-type: none"> • Bleed air • Check and replace with a new one or repair if necessary • Check and repair if necessary • Contact your distributor
Engine stops when set to low speed	<ul style="list-style-type: none"> • Failure in engine 	<ul style="list-style-type: none"> • Contact your distributor
Engine suddenly stops during operation	<ul style="list-style-type: none"> • Insufficient fuel • Insufficient engine oil • Failure in engine 	<ul style="list-style-type: none"> • Check and add fuel • Check and add fuel • Contact your distributor



10.2 PROBLEMS WITH CHASSIS RELATED PARTS

Problem	Main causes	Remedy
Machine does not move	<ul style="list-style-type: none"> • Leakage of oil from hydraulic system • Defective travel lever linkage • Failure in hydraulic equipment 	<ul style="list-style-type: none"> • Check and repair if necessary • Check and repair if necessary • Contact your distributor
Abnormal noise coming from around pump	<ul style="list-style-type: none"> • Clogged strainer inside hydraulic tank • Leakage of oil from hydraulic system • Failure in hydraulic equipment 	<ul style="list-style-type: none"> • Check and clean, or replace with a new one if necessary • Check and repair if necessary • Contact your distributor
Hydraulic oil temperature increases too high	<ul style="list-style-type: none"> • Insufficient oil in hydraulic tank • Loose fan belt • Clogging of oil cooler fin • Leakage of oil from hydraulic system • Overloading, operation under excessive load 	<ul style="list-style-type: none"> • Check and add fuel • Check and adjust, or replace with a new fan belt if necessary • Check and clean • Check and repair if necessary • Reduce to below max. payload
Rubber crawler comes off	<ul style="list-style-type: none"> • Rubber crawler tension too loose 	<ul style="list-style-type: none"> • Check and adjust if necessary
Abnormal wear on sprocket	<ul style="list-style-type: none"> • Rubber crawler tension too tight 	<ul style="list-style-type: none"> • Check and adjust if necessary



10.3 PROBLEMS WITH ELECTRIC RELATED PARTS

Problem	Main causes	Remedy
During operation, the "charge lamp" on the instrument panel lights up. (Battery does not charge up)	<ul style="list-style-type: none"> • Defective wiring • Loose fan belt • Faulty alternator • Defective battery function 	<ul style="list-style-type: none"> • Check and repair if necessary • Check and adjust if necessary, or replace with a new fan belt • Contact your distributor • Check and repair or replace if necessary
Headlights are not bright	<ul style="list-style-type: none"> • Battery charge is too low • Faulty alternator 	<ul style="list-style-type: none"> • Charge • Contact your distributor
No lights light up	<ul style="list-style-type: none"> • Blown fuse • Defective wiring • Defective light switch 	<ul style="list-style-type: none"> • Check and replace if necessary • Check and repair if necessary • Check and replace if necessary
Individual headlights and gauge lamps do not light up	<ul style="list-style-type: none"> • Blown bulb • Defective wiring 	<ul style="list-style-type: none"> • Replace • Check and repair if necessary
Horn does not sound	<ul style="list-style-type: none"> • Blown fuse • Defective horn • Defective horn • Defective horn switch 	<ul style="list-style-type: none"> • Check and replace if necessary • Check and replace if necessary • Check and replace if necessary • Check and replace if necessary



MAINTENANCE

1. Basic outline of maintenance	3 - 2
2. Precautions for maintenance	3 - 4
3. Use of fuel and lubricants according to ambient temperature	3 - 6
4. Tools and tightening torques	3 - 8
5. Periodic replacement of critical parts	3 - 10
6. Maintenance schedule chart	3 - 12
7. Maintenance procedures	3 - 14



1. BASIC OUTLINE OF MAINTENANCE

[1] OIL

- Oil is used under extremely heavy-duty conditions (high temperature, high pressure) in the engine, hydraulic pump, motor, and work equipment. Therefore, it deteriorates as time passes. Always use oil of the grade specified according to the ambient temperature as listed in this operation manual. Even if the oil is not dirty, always change it at the specified interval.
- When adding oil, do not mix oils of different grades or brands.
- Always add oil to the specified oil level. Too much oil and too little oil can cause problems.
- When changing the oil, always replace the related oil filter at the same time.
- Always be careful when handling oil to prevent water, dirt, or other impurities from getting into the oil. A large proportion of problems with the machine are caused by impurities getting into the oil, so be extremely careful not to let them get into the oil. Always store the oil indoors and fill the oil in a dust-free environment.
- If the oil is milky white, there is probably water or air in the circuit. In such cases, please contact your distributor.

[2] FUEL

- Use ultra-low sulfur diesel fuel (light oil with sulfur content of 15 ppm or lower) as fuel.
- Do not use any fuel except diesel oil.
- Always use fuel of the grade specified according to the ambient temperature as listed in this operation manual.
- The fuel injection pump is a precision instrument. If fuel containing water or dirt is used, the fuel pump stops working. Be extremely careful not to let impurities get into the fuel. Always store the fuel indoors and refuel in a dust-free environment.
- If fuel is stored in drum cans, store the drum cans on their sides so that the ports in the drum cans are in a straight line to the side. This prevents damp air from being sucked in.
- To prevent moisture in the air from getting into the fuel tank, always fill the tank after the completion of each day's work.
- If the machine runs out of fuel, or when the fuel filter has been replaced, it is necessary to bleed the air in the circuit. Always read the separate operation manual for the engine when carrying out this operation.

[3] COOLANT

- Do not use river water, well water, or water from simple water lines as the coolant. Such kinds of water contain many impurities, such as calcium and dirt, so scale collects on the inside of the engine and radiator. This can cause improper heat exchange, leading to overheating.
- If the engine overheats, allow the engine to cool down, then add coolant.
- When using anti-freeze, always follow the precautions given in the operation manual.

[4] GREASE

- Grease is used at the connecting points of the dump body to prevent gouging or noise.
- The grease nipples not listed in this manual are nipples used for overhaul, so there is no need to add grease to them. However, if any gouging or noise occurs during use, add grease.
- When adding grease, pump in grease until the old grease is completely forced out, then wipe off all the old grease. In particular, thoroughly wipe off the grease at points where mud and dirt may stick and cause wear of the rotating parts.



[5] FILTERS

- Filters are used to prevent trouble caused when impurities in the oil, fuel, or air enter important equipment. When the replacement interval listed in this manual is reached, always replace or clean the filters.
However, when using the machine under heavy-duty conditions, replace the filters before the specified replacement interval has passed.
- Do not wash and reuse oil filters or fuel filters. Always replace them with new ones.
- When replacing the oil filter, check the old filter for any metal particles or pieces of rubber from the hoses. If any rubber or metal is found, please contact your distributor. This is important to prevent any failure before it occurs.
- When using new filters, do not remove the wrapping until immediately before using them.

[6] ELECTRICAL COMPONENTS

- It is extremely dangerous if electrical components become wet or the film covering them is broken. This may lead to an electrical short, resulting in a malfunction of the machine.
When washing the machine, take care not to get water onto the electrical components.
- Never remove any electrical components from the machine or disassemble them.
- Always contact your distributor before installing additional electrical components to your machine.
- After the machine has been used near the sea or after it has been used for spreading fertilizer, wipe the electrical components carefully with a dry cloth to prevent corrosion.

[7] HYDRAULIC EQUIPMENT

- The hydraulic equipment is at high temperature and high pressure during operations and immediately after operations have been completed.
When carrying out inspections and maintenance of the hydraulic equipment, always do as follows.
 - (1) Stop the machine on level ground, and lower the work equipment to the ground so that there is no pressure in the hydraulic cylinder circuit.
 - (2) Always stop the engine.
 - (3) Loosen the hydraulic tank cap slowly, then remove it.
 - (4) Always wait for the temperature to cool down before starting maintenance. Even when the temperature cools down, the circuits are still under internal pressure, so when removing plugs or hoses, do not stand directly in front of them, and loosen the connections slowly before removing.
- If high-pressure hoses, connections, or hydraulic equipment have been removed, always replace the O-ring.
- When replacing or cleaning the hydraulic oil line filter or strainer, or when replacing or repairing the hydraulic equipment or hoses, always bleed the air from the circuit after completion of the operation.



2. PRECAUTIONS FOR MAINTENANCE

WARNING

- Before carrying out inspection and maintenance, always read “2. PRECAUTIONS DURING INSPECTION AND MAINTENANCE in the SAFETY” volume and make sure that you understand the safety procedures for operations.
- Do not carry out any operation not listed in this manual for inspections and maintenance. When carrying out inspections and maintenance of the engine, thoroughly read and understand the contents of the separate engine operation manual.

[1] CHECK HOUR METER

- Read the hour meter every day to check if the required interval has been reached for any maintenance item.

[2] USE GENUINE PARTS

- When replacing parts, always use the genuine parts specified in the parts list.

[3] PRECAUTIONS WHEN ADDING OR CHANGING OIL/GREASE

- When adding or changing fuel, oil, or grease, always use the type specified by Morooka. Be sure to use the viscosity specified for the ambient temperature.
- Never mix oils of different types or brands.
- The oil used when the machine is shipped from the factory is as shown in the table below.

Item	Type	Brand
Engine oil pan	CF/CH-4 10W-30	JXTG Nippon Oil & Energy Corporation Diesel DH-1/CF
Hydraulic tank	Hydraulic oil #46	JXTG Nippon Oil & Energy Corporation Super Hyrando 46
Travel motor reduction gear case	SAE90 GL-4	JXTG Nippon Oil & Energy Corporation Gear oil GL-4 90

[4] PRECAUTIONS WHEN WASHING OR CLEANING MACHINE

- Wash or clean the machine to make it easier to locate problem areas. In particular, wash the oil filler, level gauge, and greasing plugs to prevent dirt or mud from entering when adding oil or grease.
- Cover electrical components, such as the starting motor or alternator, with a sheet to prevent water from getting on them.
- Do not carry out high-pressure washing for the radiator or oil cooler parts.

[5] BE CAREFUL OF OIL/COOLANT TEMPERATURE

- It is dangerous to drain the oil/coolant or replace the filters immediately after stopping the engine. Wait for the machine to cool down before carrying out such operations.
- When draining the oil, warm up the oil to a suitable temperature [approx. 20 to 40 deg. C (68 to 104 deg. F)] before carrying out the operation.

[6] PRECAUTIONS WHEN CHECKING OIL LEVEL/ADDING OIL

- When checking the oil level or adding oil, choose a place where there is no dust to prevent dirt from entering the oil line.
- Use clean oil and grease. Use a clean container to prevent dirt from getting in.
- If there is a strainer fitted to the oil filler, do not remove the strainer when adding oil.
- The oil level should not be too high or too low. Check that the lubricating oil is at the correct level.

**[7] CHECKING DRAINED OIL/FILTER**

- When the oil has been changed or the filter replaced, always check the drained oil and removed filter to check for metal particles or other foreign matter.

[8] SETTING UP WARNING SIGNS

- When the oil or coolant has been drained, put warning signs (Part No.: 1-41010-1210) in the operator's compartment to prevent anyone from starting the engine by mistake.

[9] PRECAUTIONS WHEN WASHING PARTS

- When washing parts, use a non-flammable cleaning agent or diesel oil. When using diesel oil, do not bring lighted cigarettes or cigarette lighters close.

[10] PRECAUTIONS WHEN INSTALLING PARTS

- When O-rings, gaskets, or other seals are used for the mounting surface, clean the mounting surface and always replace the seal with a new part.

[11] PRECAUTIONS WHEN CARRYING OUT INSPECTIONS AND MAINTENANCE ON A MACHINE AFTER OPERATIONS IN DUSTY AREAS

- Check the air cleaner for clogging frequently (check the dust indicator), and clean the air cleaner element at shorter intervals.
- Clean the radiator core and oil cooler core at shorter intervals to prevent clogging.
- Replace the fuel filter at shorter intervals.
- Clean electrical components, such as the starting motor and alternator frequently.

[12] PRECAUTIONS WHEN CARRYING OUT INSPECTIONS AND MAINTENANCE ON MACHINES BEFORE STARTING OPERATIONS IN SWAMPY AREAS, RAIN, RIVERBEDS, OR SNOW

- Before starting operations, check that the drain plug under the engine and the greasing plugs for the track rollers are securely tightened.
- After completion of operations, wash the machine carefully and check for cracks and damage, and for loose or missing nuts and bolts.



3. USE OF FUEL AND LUBRICANTS ACCORDING TO AMBIENT TEMPERATURE

3.1 FUEL, COOLANT, AND LUBRICANT TABLE

NOTICE

- Engine oil has a substantial impact on the performance, service life, and starting performance of the engine. Be sure to use engine oil with the grade CF, CF-4 or CI-4 class with the specified viscosity according to the ambient temperature (see the table below).
- Be sure to use ultra-low sulfur diesel fuel (sulfur 15 ppm or lower) as fuel. Never use additives such as anti-freeze agents, water solubilizers, etc. Using them can damage the fuel injection system. Never use substitute fuels such as irregular bio-based fuel heating oil that can cause machine failure.

- Select the fuel and oil from the table below according to the ambient temperature.
- The specified capacity is the total amount of oil, including the oil in the piping of the various components.
- The refill capacity is the amount of oil added when changing the oil during inspections and maintenance.
- When starting the engine in an ambient temperature of 0 deg. C or lower, always use a grade specified for temperatures below 0 deg. C, even if the temperature goes up to 10 deg. C during the daytime.
- For the anti-freeze mixing rate of coolant, see "7. COLD WEATHER OPERATION in OPERATION".

RESERVOIR	KIND OF FLUID	AMBIENT TEMPERATURE									CAPACITY	
		-22 -30	-4 -20	14 -10	32 0	50 10	68 20	86 30	104°F 40°C	Specified	Refill	
Engine oil pan	Engine oil	SAE15W-40									6.5 l 1.72 US gal 1.43 UK gal	6.5 l 1.72 US gal 1.43 UK gal
		SAE10W-30										
Hydraulic oil tank	Hydraulic oil	ISO VG56									45 l 11.9 US gal 9.9 UK gal	42 l 11.1 US gal 9.2 UK gal
		ISO VG46										
		ISO VG32										
Travel motor reduction gear case(each)	Gear oil	SAE90									0.6 l 0.16 US gal 0.13 UK gal	—
Fuel tank	Diesel fuel	ASTM D975 No.2									50 l 13.2 US gal 11.0 UK gal	—
		ASTM D975 No.1										
Cooling system	Water, LLC	Water, Long Life Coolant Mixture									7 l 1.8 US gal 1.5 UK gal	—

**REMARK**

- When starting the engine in an atmospheric temperature of lower than 0°C (32°F), be sure to use engine oil of SAE10W-30 and SAE15W-40, even though an atmospheric temperature goes up to 10°C (50°F) more or less in the day time.
- There is no problem if single grade oil is mixed with multigrade oil (SAE10W-30, 15W-40), but be sure to add single grade oil that matches the temperature in the table.
- We recommend genuine oil which has been specifically formulated and approved for use in engine and hydraulic work equipment applications.

Specified capacity: Total amount of oil including oil for components and oil in piping.

Refill capacity: Amount of oil needed to refill system during normal inspection and maintenance.

ASTM: American Society of Testing and Material

SAE: Society of Automotive Engineers

API: American Petroleum Institute

- Hydraulic oil: JXTG Nippon Oil & Energy Super Hyrando 46
★ When changing the hydraulic oil, please contact your distributor.



4. TOOLS AND TIGHTENING TORQUES

4.1 SUPPLIED TOOLS

The following tools are required for maintenance.

If a tool is broken or worn, please order a new tool from your distributor.

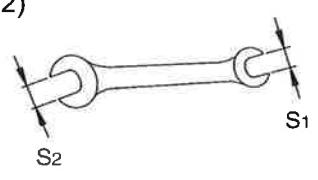
No.	Name of tool	Part No.	Remarks
1	Wrench set	0-9100-00000 0-9100-00709 0-9100-00810 0-9100-01113 0-9100-01214 0-9100-01719 0-9100-02224	Width across flats (S1 x S2) 7 mm x 9 mm 8 mm x 10 mm 11 mm x 13 mm 12 mm x 14 mm 17 mm x 19 mm 22 mm x 24 mm  <p style="text-align: right;">AD053370</p>
2	Wrench	0-9105-04600	Width across flats 46 mm
3	Screw driver	0-9210-00150	(+)
4	Screw driver	0-9200-00200	(-)

4.2 TORQUE LIST FOR BOLTS AND NUTS

Unless otherwise specified, tighten the metric bolts and nuts to the torque shown in the table below. The tightening torque is determined by the width across flats (b) of the nut and bolt.

NOTICE

When tightening panels or other parts with tightening fixtures made of plastic, do not use excessive tightening torque. Overtightening can damage the plastic parts. Be extremely careful when tightening.

Thread diameter (a) x Pitch (mm x mm)	Wrench size mm	Tightening torque (kgf-m) {N-m}	
		Tensile strength 4T	Tensile strength 11T
3 x 0.5	5.5	0.05 {0.5}	0.2 {1.8}
4 x 0.7	7	0.1 {1.0}	0.4 {4.1}
5 x 0.8	8	0.2 {2.2}	0.8 {8.2}
6 x 1.0	10	0.4 {3.6}	1.4 {14.0}
8 x 1.25	13	0.9 {8.9}	3.5 {34.0}
10 x 1.5	17	1.8 {17.7}	6.9 {67.4}
12 x 1.75	19	3.2 {30.9}	12.0 {117}
14 x 2.0	22	5.0 {49.1}	19.1 {187}
16 x 2.0	24	7.8 {76.7}	29.7 {291}
18 x 2.5	27	10.7 {105}	40.9 {401}
20 x 2.5	30	15.3 {149}	58.1 {570}
22 x 2.5	32	20.8 {203}	79.0 {775}
24 x 3.0	36	26.4 {258}	100 {983}
27 x 3.0	41	38.6 {378}	147 {1440}
30 x 3.5	46	52.4 {513}	199 {1955}
33 x 3.5	50	71.3 {699}	271 {2660}
36 x 4.0	55	91.6 {898}	348 {3416}
39 x 4.0	60	119 {1162}	451 {4421}

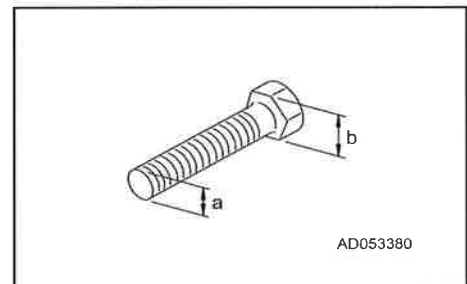



5. PERIODIC REPLACEMENT OF CRITICAL PARTS

5.1 PERIODIC REPLACEMENT INTERVAL (EVERY 2 YEARS)

In order to further increase the safety of the machine Morooka recommends periodic inspection and replacement of critical parts (hydraulic hoses, fuel hoses, etc.) which are related to causes of fire and to efficiency in the raising and lowering of the dump body and traveling and stopping functions of the machine.

With these parts, the material changes as time passes, and they easily wear or deteriorate. However, it is difficult to judge the condition of the parts simply by periodic maintenance, so they should always be replaced after a fixed time has passed, regardless of their condition. Always replace them with new genuine parts to ensure that the machine always maintains its function completely.

5.2 PERIODIC INSPECTION

WARNING

- **Check the hydraulic hoses and fuel hoses carefully for cracks, deterioration, or other damage, and check that there is no leakage from the connections. When carrying out checks before starting, always check the ground under the machine for traces of oil leakage.**
- **When replacing the hydraulic hoses or fuel hoses, always order genuine parts. Never use any imitation or substitute parts.**
- **When any hydraulic hose is replaced, always replace the O-rings at the same time. Failure to do can cause oil leakage.**

If the monthly inspection or checks before starting show any abnormality, such as leakage of oil or deformation and cracking, tighten the parts immediately or replace them with new genuine parts.

When doing this, check the hose clamps at the same time, and replace them if they are deformed or cracked.

Check and repair any hydraulic hoses, even if they are not listed as critical parts.

The table below shows the checks to be carried out during periodic maintenance.

Periodic maintenance interval	Check item
Checks before starting	<ul style="list-style-type: none"> • Leakage of oil from connected/crimped sections of fuel hoses and hydraulic hoses
Monthly inspection	<ul style="list-style-type: none"> • Leakage of oil from connected/crimped sections of fuel hoses and hydraulic hoses • Damage to fuel hoses and hydraulic hoses (cracks, wear, gouging, swelling, crushing) • Interference with other parts
Every 2 years inspection	<ul style="list-style-type: none"> • Replacement of critical parts • Leakage of oil from connected/crimped sections of fuel hoses and hydraulic hoses • Damage to fuel hoses and hydraulic hoses (cracks, wear, gouging, swelling, crushing) • Interference with other parts



5.3 SPECIFIED PERIODIC REPLACEMENT PARTS

! CAUTION

- The list of periodic replacement parts specified by Morooka does not include the fuel hoses in the engine. See the separate engine parts list (parts book) and carry out replacement in the same way as for the periodic replacement parts specified by Morooka.
- See the parts list (parts book) for part numbers for the periodic replacement parts specified by Morooka and contact your distributor to place orders.

The parts shown in the table below are specified as the periodic replacement parts. See the parts list (parts book) for details on each part.

No.	Periodic replacement parts	Q'ty	Replacement interval
1	Fuel hose (fuel tank to water separator)	1	Replace every 2 years
2	Fuel hose (water separator to fuel pump)	1	
3	Fuel hose (fuel pump to fuel filter)	1	
4	Fuel hose (fuel filter to engine)	1	
5	Fuel hose (engine to fuel tank)	1	
6	Hydraulic hose (main pump to control valve)	2	
7	Hydraulic hose (control valve to rotary center joint)	4	
8	Hydraulic hose (rotary center joint to left/right travel motor)	4	
9	Hydraulic hose (control valve to manifold)	2	
10	Hydraulic hose (manifold to dump cylinder)	4	
11	Hydraulic hose (control valve to swing motor)	2	
12	Seat belt	1	Replace every 3 years

- ★ When the fuel hose is replaced, always replace the clamp at the same time.
- ★ Hoses provided by the engine manufacturer shall be replaced at a time by referring the engine operation manual and the engine parts list.
- ★ In addition to the above list, there are periodic replacement parts specified by the manufacturer. Refer to the engine operation manual and the engine parts list for the periodic replacement parts specified by the manufacturer.



6. MAINTENANCE SCHEDULE CHART

Maintenance item	Page
7.2 INITIAL 50 HOUR MAINTENANCE ★ This is for new machines only after the first 50 hours of operation.	3-14
[1] Clean air cleaner element	3-17
[2] Check electrolyte level	3-26
[3] Change engine lubricating oil	3-27
[4] Drain water and sediment from water separator	3-28
[5] Check cooling fan for damage	3-28
[6] Replace engine oil filter	3-29
[7] Check air cleaner hose, closed breather hose	3-30
[8] Check radiator hose, clamp	3-30
7.3 INITIAL 100 HOUR MAINTENANCE ★ This is for new machines only after the first 100 hours of operation.	3-14
[1] Replace hydraulic oil line filter	3-34
[2] Change oil in hydraulic tank	3-35
7.4 INITIAL 500 HOUR MAINTENANCE ★ This is for new machines only after the first 500 hours of operation.	3-14
[1] Change oil inside travel motor reduction gear case	3-37
7.5 CHECKS WHEN REQUIRED ★ If necessary, carry out these checks every day.	3-15
[1] Check and adjust the rubber crawler tension	3-15
[2] Check rubber crawler for damage and wear	3-16
[3] Check air cleaner and clean or replace	3-17
[4] Clean inside of cooling system and change coolant	3-18
[5] Check and clean radiator, oil cooler fin	3-20
7.6 CHECKS BEFORE STARTING ★ Always carry out the following checks before starting the engine.	3-21
[1] Check coolant level and add water	3-21
[2] Check fuel level and add fuel	3-21
[3] Check engine lubricating oil level and add oil	3-22
[4] Check oil level in hydraulic tank and add oil	3-23
[5] Check fan belt tension and adjust	3-23
[6] Check electrical wire	3-24
[7] Check operation of switches, lamps, gauges	3-24
[8] Check operation of horn	3-24
7.7 EVERY 50 HOUR MAINTENANCE	3-25
[1] Drain water and sediment from fuel tank	3-25
[2] Check fuel hoses and clamps	3-25
7.8 EVERY 100 HOUR MAINTENANCE	3-26
[1] Check battery electrolyte level and add distilled water	3-26
[2] Change engine lubricating oil	3-27
[3] Drain water and sediment from water separator	3-28
[4] Clean air cleaner element	3-28
[5] Check cooling fan for damage	3-28



Maintenance item	Page
7.9 EVERY 200 HOUR MAINTENANCE	3-29
[1] Replace engine oil filter	3-29
[2] Check air cleaner hose, closed breather hose	3-30
[3] Check radiator hose, clamp	3-30
7.10 EVERY 250 HOUR MAINTENANCE	3-31
[1] Grease dump body rear side flap operating rods	3-31
[2] Check swing pinion part grease level, add grease if necessary	3-31
[3] Grease swing bearing	3-31
7.11 EVERY 450 HOUR MAINTENANCE	3-32
[1] Clean water separator	3-32
[2] Replace fuel filter	3-33
7.12 EVERY 500 HOUR MAINTENANCE	3-34
[1] Replace hydraulic oil line filter	3-34
[2] Change oil in hydraulic tank	3-35
[3] Replace fan belt	3-36
7.13 EVERY 800 HOUR MAINTENANCE	3-36
[1] Adjust valve clearance	3-36
[2] Measure compression pressure	3-36
7.14 EVERY 1500 HOUR MAINTENANCE	3-37
[1] Change oil inside travel motor reduction gear case	3-37
[2] Check, clean injection nozzle	3-37
7.15 EVERY 3000 HOUR MAINTENANCE	3-37
[1] Check fuel injection pump	3-37
[2] Check turbo charger	3-37



7. MAINTENANCE PROCEDURES

7.1 OUTLINE OF MAINTENANCE PROCEDURES

This section explains the inspections and maintenance procedures listed in "6. MAINTENANCE SCHEDULE CHART in MAINTENANCE".

Always observe the precautions related to safety for each item and carry out the procedures.

Do not attempt to carry out the procedure if you feel it is difficult. Please contact your distributor.

- Procedures provided in this section require the following parts to be removed or opened, and then installed or closed. For details on these procedures, see the following sections in OPERATION.

(1) Engine cover: See "2.12 ENGINE COVER in OPERATION."

(2) Operator's seat side cover: See "2.13 OPERATOR'S SEAT SIDE COVER in OPERATION"

(3) Battery inspection cover: See "2.14 BATTERY INSPECTION COVER in OPERATION".

7.2 INITIAL 50 HOUR MAINTENANCE

Carry out the following maintenance after the initial 50 hours break-in operation for new machines.

- [1] Clean air cleaner element
- [2] Check electrolyte level
- [3] Change engine lubricating oil
- [4] Drain water and sediment from water separator
- [5] Check cooling fan for damage
- [6] Replace engine oil filter
- [7] Check air cleaner hose, closed breather hose
- [8] Check radiator hose, clamp

7.3 INITIAL 100 HOUR MAINTENANCE

Carry out the following maintenance after the initial 100 hours operation for new machines.

- [1] Replace hydraulic oil line filter
- [2] Change oil in hydraulic tank

For details of the maintenance procedures, see "EVERY 200 HOUR MAINTENANCE, EVERY 50 HOUR MAINTENANCE".

7.4 INITIAL 500 HOUR MAINTENANCE

Carry out the following maintenance after the initial 500 hours of operation for new machines.

- [1] Change oil inside travel motor reduction gear case

For details of the maintenance procedures, see "EVERY 1500 HOUR MAINTENANCE".

7.5 CHECKS WHEN REQUIRED

[1] CHECK AND ADJUST RUBBER CRAWLER TENSION

WARNING

The tension adjuster for the rubber crawler is charged with grease. The grease is kept under high pressure by the recoil spring inside the tension adjuster. Always follow the precautions given below. Failure to do so may cause the valve to fly out, resulting in serious injury or accident.

- Never loosen the tension adjustment valve more than one turn. There is a danger that the valve may fly out.
- When adjusting the tension, never stand directly in front of the valve. It is dangerous.

• CHECKING TENSION

1. Move the machine a short distance forward and backward, and then stop the engine.
2. Measure distance **A** from the front end of the track frame to the inner tread of the rubber crawler, and check that it is within the following range.
 - ★ Dimension **A**: 95 ± 5 mm
 - ★ If the result of the measurement shows that dimension **A** is greater than the specified range, adjust the rubber crawler tension.

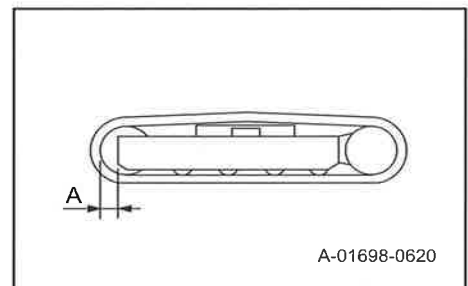

• ADJUSTING WHEN TENSION IS LOOSE (When measurement is below the range for dimension A)

- ★ Before adjusting, prepare a grease pump.
1. Remove 2 bolts, and then remove the grease valve cover (1).
 2. Using the grease pump, pump in the grease through valve (2) until dimension **A** is within the range given in "CHECKING TENSION".
 - ★ If dimension **A** does not enter the range above even when grease is pumped in, the rubber crawler must be replaced, or there is probably some abnormality in the tension adjuster. Please contact your distributor.
 3. Move the machine a short distance forward and backward to make the tension uniform, and then repeat the steps in "CHECKING TENSION" to measure dimension **A**.
 4. Install the grease valve cover (1), and then tighten the bolts.

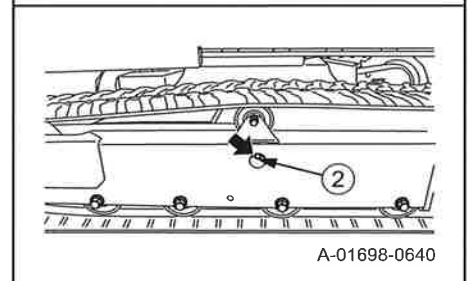
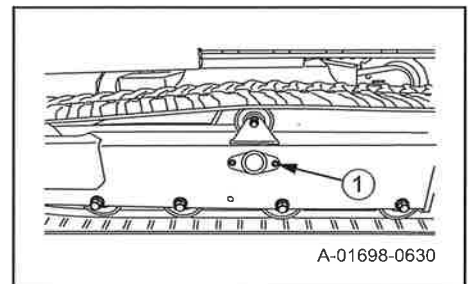



• **ADJUSTING WHEN TENSION IS TIGHT**
(When measurement is above range for dimension A)

★ Before adjusting, prepare a grease pump.

1. Remove 2 bolts, and then remove grease valve cover (1).

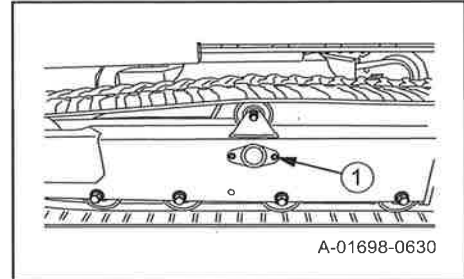

2. Loosen the valve (2), then drain grease through valve (2) until dimension **A** falls in the criteria of A given in "CHECKING TENSION".

★ If the grease comes out slowly, push the idler end of the rubber crawler firmly. Never loosen valve (2) more than 1 turn.

★ If the grease still comes out slowly, start the engine and move the machine a short distance forward and backward.

3. Tighten valve (2) firmly.

4. Move the machine a short distance forward and backward to make the tension uniform, and then repeat the steps in "CHECKING TENSION" to measure dimension A.

5. Install grease valve cover (1), and then tighten the bolts.

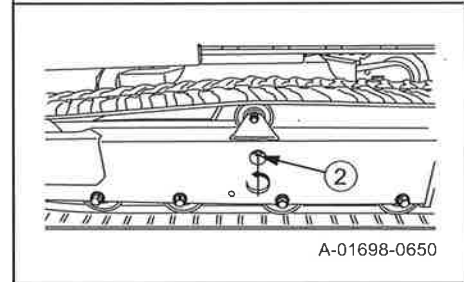

[2] CHECK RUBBER CRAWLER FOR DAMAGE AND WEAR

WARNING

If there are any large cracks or damage to the rubber crawler, replace the rubber crawler immediately. The rubber crawler may break suddenly without warning during operation.

NOTICE

• When checking the rubber crawler, remove all mud and snow from the crawler beforehand.
• Using the rubber crawler when it has exceeded the wear limit can cause slipping and reduce the drawbar pull. If the rubber crawler is in the following condition, replace it with a new one.

• If the height of the lug is 1/3 or less of the standard dimension, replace the rubber crawler.

★ Standard height: 25 mm

★ Wear limit: 10 mm

• If there are cracks or deep cuts and the wire in the core of the rubber crawler can be seen, replace the rubber crawler.

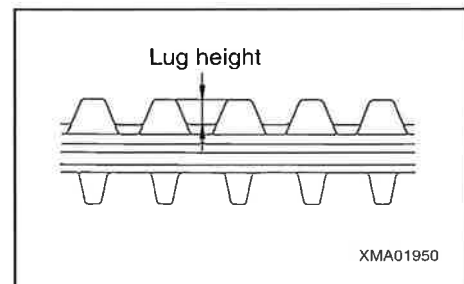

[3] CHECK AIR CLEANER AND CLEAN OR REPLACE

WARNING

- Never clean, or replace the air cleaner when the engine is running. Always stop the engine before checking the air cleaner.
- When using compressed air to clean the element, there is a danger that dirt and dust may fly and get into eyes. Always wear safety glasses.

NOTICE

- When cleaning the element, do not hit it or knock it against other objects.
- Do not use the element if the folds or seal are damaged.
- Replace the element with a new one after it has been cleaned 3 to 4 times or it has been used for over a year.
- After cleaning the element, if the engine exhaust color is black and the engine power is insufficient, replace the element with a new one.

• CLEANING ELEMENT

1. Open the engine cover.
 2. Remove butterfly bolt (1) from the air cleaner.
 3. Remove element (2) from the engine rear cover side.
4. Blow with dry compressed air (max. 0.68 MPa {7 kgf/cm²}) along the folds from the inside of element (2).
Next, blow along the folds from the outside of the element, then blow from the inside of the element again.
5. After cleaning, illuminate the inside of the element with a bulb to check for small holes and thin sections. If any are found, replace the element with a new one.
 6. After cleaning element (2), insert it into the body.
 7. Install butterfly bolt (1) and tighten it.
 8. Close the engine cover.

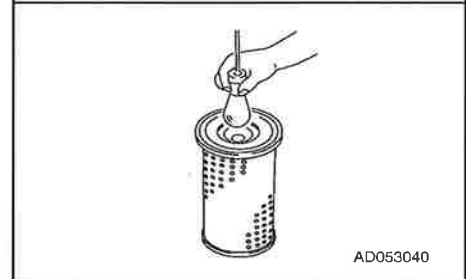
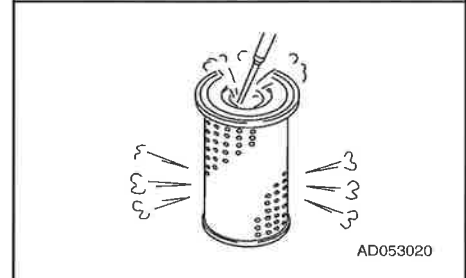
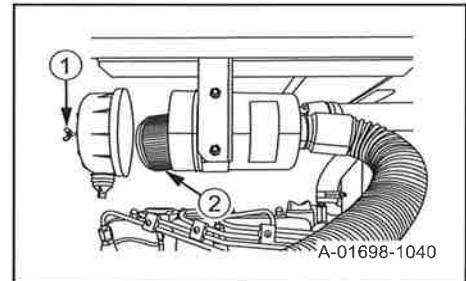

• REPLACING ELEMENT

Remove the element by referring to "CLEANING ELEMENT" and replace with a new one.

[4] CLEAN INSIDE OF COOLING SYSTEM AND CHANGE COOLANT

⚠ WARNING

- Immediately after the engine is stopped, the coolant is at high temperature, so there is a danger of burns if you drain the water immediately. Wait for the engine to cool down before draining the coolant.
- Do not suddenly remove the radiator cap when the radiator coolant temperature is high. Boiling water may spurt out and cause burns. Wait for the water temperature to cool down before removing the radiator cap.
When removing the radiator cap, wait for the water temperature to cool down and turn the radiator cap slowly to fully release the internal pressure, then remove.

NOTICE

- Change the coolant every year or 2000 operating hours whichever comes first.
- For the anti-freeze mixing rate of coolant, see "7. COLD WEATHER OPERATION in OPERATION".
- If the air is not bled sufficiently after coolant has been changed or radiator has been replaced, the engine may overheat. Ensure that the air in the coolant system is bled completely.

Follow the procedure below to clean the inside of the cooling system.

★ Use mixture of long-life coolant and tap water for the coolant. Do not use river water, well water, or untreated water supplies.

1. Stop the machine on a level ground and stop the engine.
2. Loosen bolt (1). Open radiator cover (2).

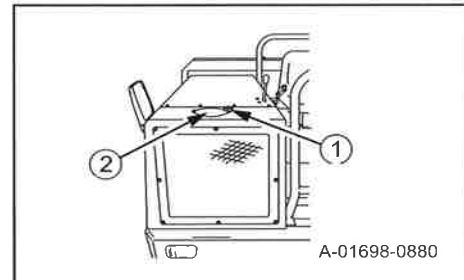

3. Turn the radiator cap (5) slowly to remove.
4. Open the engine cover.

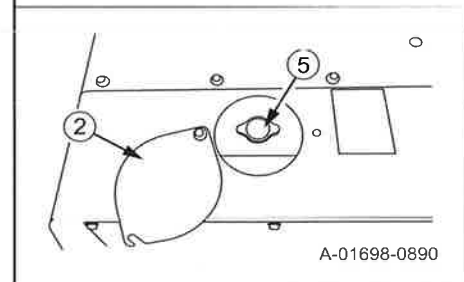



5. Drain coolant by opening radiator drain valve (6) and engine drain valve (7).

★ Place a container under the drain valve to catch the mixture.

6. After draining the coolant, close the drain valves (6) and (7), then add tap water through the water filler to fill the radiator.

7. Open drain valve (6). Start the engine, run at low idle, and run water through the system to flush it for 10 minutes.

★ While running water through the cooling system to flush it, adjust the water flow so that the radiator is always full.

★ While running water through the cooling system to flush it, be careful that the water supply hose does not slip out of the water filler.

8. After flushing the system, stop the engine, stop the water supply, and then drain the water.

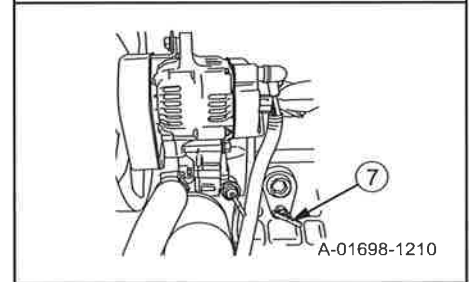
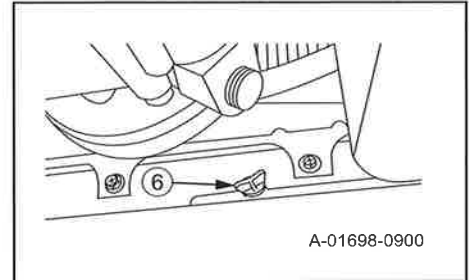

9. After draining the water, close drain valve (6), then add cleaning agent through the water filler.

★ See the instructions on the cleaning agent for the cleaning procedure.

10. After flushing with cleaning agent, open drain valve (6), drain water, then start the engine, run at low idle, and flush with water until clean water comes out.

★ While running water through the cooling system to flush it, adjust the water flow so that the radiator is always full.

★ While running water through the cooling system to flush it, be careful that the water supply hose does not slip out of the water filler.

11. When clean water comes out, stop the engine and stop the water supply. When water has stopped coming out of drain valve (6), close drain valve (6).

12. Open drain valve (7) to drain water from the engine.

13. After draining water, close drain valve (7).

14. Add coolant (mixture of tap water and long-life coolant (LLC) (with the LLC mixing rate of 50%)) through the water filler to fill the radiator.

15. Start the engine, run for 5 minutes at low idling, then run for a further 5 minutes at high idling to completely remove air from the cooling system.

★ Leave the radiator cap removed when doing this.

16. Stop the engine, leave for approximately 3 minutes, then add coolant up to near the water filler and tighten radiator cap (5).

17. Remove reserve tank (3), drain coolant and then wash inside the reserve tank (3).

18. Install reserve tank (3) to the original position. Remove cap (4) and add coolant to the level between "LOW" and "FULL". Tighten cap (4).

19. Close the engine cover.

20. Close radiator cover (2), tighten bolt (1).

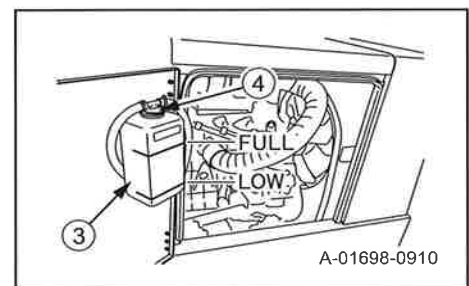

[5] CHECK AND CLEAN RADIATOR, OIL COOLER FIN

! WARNING

- Never check or clean the fins when the engine is running. Always stop the engine before checking the air cleaner.
- When using compressed air to clean the fins, there is a danger that dirt and dust may fly and get into eyes. Always wear safety glasses.

NOTICE

- When cleaning the fins, use compressed air at a pressure of less than "0.29 MPa {3 kgf/cm²}", and stand away from the fins when directing the compressed air. If the compressed air is blown directly against the condenser at high pressure, the fins will be damaged and this will cause leakage of air.
- When cleaning the fins, do not use steam or water instead of compressed air. This accelerates clogging of the fins.

1. Remove mounting bolts (1) (8 places). Install front grill (2).

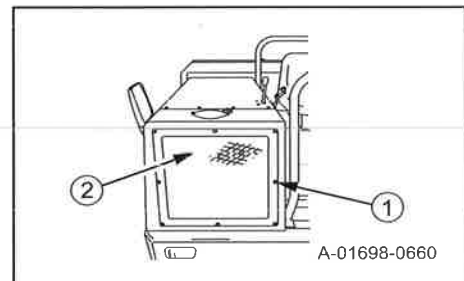

2. Check for mud, dirt, dead leaves, or waste paper clogging radiator fins (3) and oil cooler fins (4).
3. If the fins are clogged, blow with dry compressed air (max. 0.29 MPa {3 kgf/cm²}) to clean.
4. After cleaning, set front grill (2) to the original position. Tighten bolts (1).

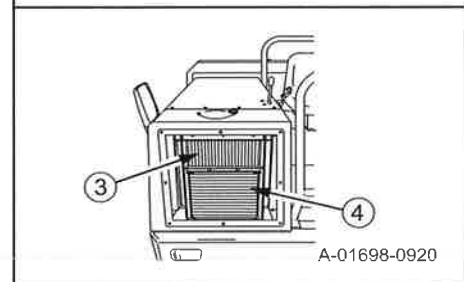



7.6 CHECKS BEFORE STARTING

[1] CHECK COOLANT LEVEL AND ADD COOLANT

WARNING

Always check coolant level and add coolant at the reserve tank part. Do not remove the radiator cap to check coolant level.

NOTICE

If the result of the coolant level check shows that more coolant must be added than usual, there is probably a coolant leak. Search for the cause and repair the problem immediately.

1. Open the engine cover.
2. Check that coolant level of reserve tank (3) is in between the "LOW" and "FULL" marks.
If coolant level is low, add coolant.
3. Remove cap (4) from reserve tank (3). Check that coolant level of reserve tank (3) is in between the "LOW" and "FULL" marks.
4. After adding coolant, tighten Cap (4) securely.
5. Close the engine cover.

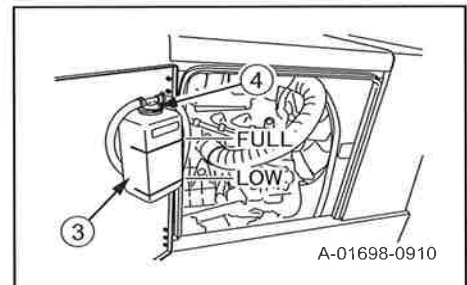

[2] CHECK FUEL LEVEL AND ADD FUEL

DANGER

When adding fuel, never let the fuel overflow from the tank. This can cause a fire. Wipe it completely when the fuel spills.

1. Check the fuel level with level gauge (1) on the side of the fuel tank.
If fuel has not been filled up, refill fuel.
 2. Unlock cap (1) with a key and remove the cap (2) from the fuel tank, then add fuel through the oil filler.
 3. Check the breather hole inside the cap and clean it if it is clogged.
 4. After adding fuel, close cap (1) and lock it.
- ★ Always fill the fuel tank after completing the day's operation.

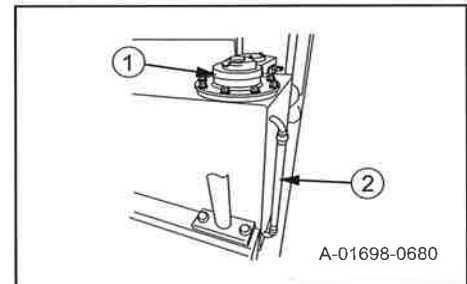

[3] CHECK ENGINE LUBRICATING OIL LEVEL AND ADD OIL

• CHECK OIL LEVEL

1. Open the engine cover.
2. Pull out dipstick (1) and wipe the oil off with a waste cloth.
3. Insert dipstick (1) fully into the gauge guide, then pull it out again.

4. The oil level should be in between the upper and lower dot-stamps on dipstick (1). If the oil level is below the lower dot, add engine oil.

5. Close the engine cover.

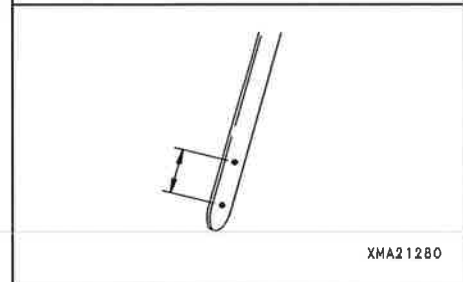
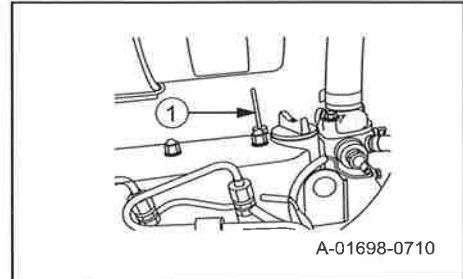

• FILLING WITH OIL

1. Open the engine cover.
2. Remove filler cap (2) and add engine oil.
 - ★For details of engine oil, see "3. USE OF FUEL, COOLANT AND LUBRICANTS ACCORDING TO AMBIENT TEMPERATURE in MAINTENACE".
 - ★Use a container with an attached hose when filling with oil.
3. After refilling with oil, check the oil level again to see if the oil level is in the normal range.
 - When the oil level is in normal range, close filler cap (2) securely.
4. Close the engine cover.

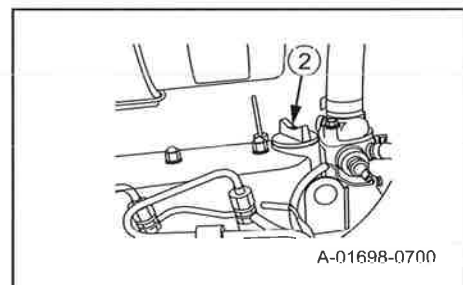



[4] CHECK OIL LEVEL IN HYDRAULIC TANK AND ADD OIL

1. Use sight gauge (1) on the side of the hydraulic tank to check oil level and contamination in oil. The oil level should be around the center of sight gauge.(1).

2. Remove filler cap (2) and add hydraulic oil from the filler port.
 - ★For details of hydraulic oil, see “3. USE OF FUEL, COOLANT AND LUBRICANTS ACCORDING TO AMBIENT TEMPERATURE in MAINTENACE”.
3. After adding oil, tighten filler cap (2) securely.

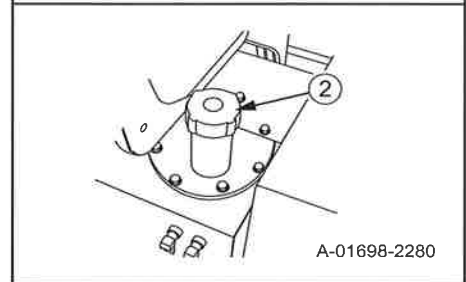
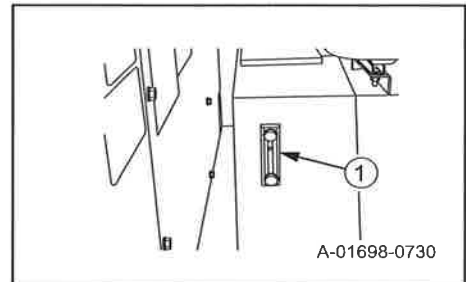

[5] CHECK FAN BELT TENSION AND ADJUST

• CHECK TENSION

1. Remove the operator’s seat side cover.
2. Push the belt with your finger (approx. 98 N {10 kg}) at a point midway between the crank pulley and alternator pulley. The deflection should be approx.10 mm.
3. If the deflection is too large, adjust the belt tension. For details, see “ADJUSTING TENSION”.

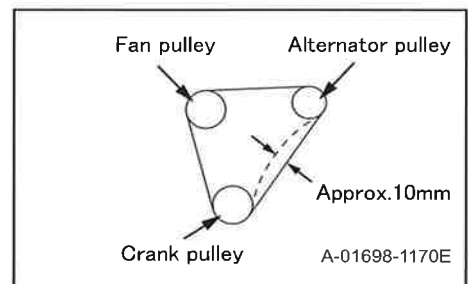

• ADJUSTING TENSION

1. Loosen lower bolt (2) and adjusting bolt (3) of alternator (1).
2. Adjust the belt deflection to approx. 10 mm by moving alternator (1) toward your side.
3. After adjusting the belt tension, tighten lower bolt (2), and then tighten adjusting bolt (3) of alternator (1).
4. Repeat the procedure for checking the tension and check the belt tension again.
5. Install the operator’s seat side cover.

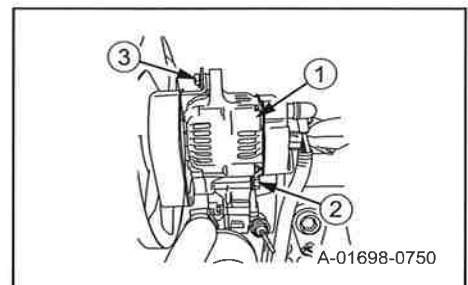



[6] CHECK ELECTRICAL WIRE

WARNING

If any tool touches between the battery positive (+) terminal and the chassis, sparks may occur. It is dangerous. Do not put tools and other metal objects in your breast pocket. They may fall out.

Open the engine cover, operator's seat side cover, and battery inspection cover and check electrical wire.

- Check for looseness of the battery terminal, ground connection wiring, and for signs of short circuits.
- Check for looseness of the starting motor wiring and signs of short circuits.
- Check for looseness of the alternator wiring and signs of short circuits.

After checking, close the engine cover, operator's seat side cover, and battery inspection cover.

[7] CHECK OPERATION OF SWITCHES, LAMPS, GAUGES

- Turn the starting switch to the ON position and check that each lamp on the instrument panel lights up.
- Turn the starting switch to the ON position and turn the light switch to the ON position to check operation of the head lamp.
 - ★ If the head lamp does not light up, the bulb may be blown or open circuit. Contact your distributor.

[8] CHECK OPERATION OF HORN

- Turn the starting switch to the ON position and push the horn switch to check operation of the horn.
 - ★ If the horn does not sound, the horn or horn relay may be faulty or open circuit. Contact your distributor.

7.7 EVERY 50 HOUR MAINTENANCE

[1] DRAIN WATER AND SEDIMENT FROM FUEL TANK

WARNING

After raising the dump body, securely set the safety bar to prevent the dump body from coming down.

★ Place a container under the fuel tank to catch fuel.

1. Raise the dump body. For details, see "4.1 OPERATING DUMP BODY in OPERATION".
2. Slightly turn drain plug (1) at the bottom of the fuel tank counterclockwise. Sediment accumulated at the bottom of the tank and water are drained together.
3. After completely draining the sediment and water, tighten drain plug (1) at the bottom of the fuel tank.
4. Lower the dump body. For details, see "4.1 OPERATING DUMP BODY in OPERATION".

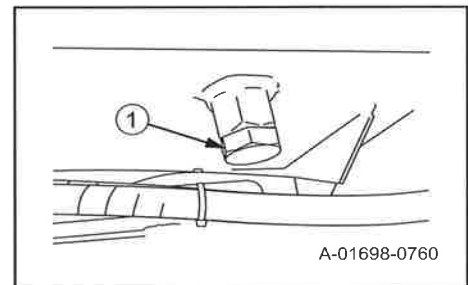

[2] CHECK FUEL HOSES AND CLAMPS

WARNING

- Stop the engine and wait for the engine to cool down.
- Do not smoke or bring any flame close.
- After raising the dump body, securely set the safety bar to prevent the dump body from coming down.

1. Raise the dump body. For details, see "4.1 OPERATING DUMP BODY in OPERATION".
2. Open the engine cover.
3. Check fuel hose (1) for cracks and flaws. Check clamp (2) for looseness.
 - ★ The figure on the right shows periphery of the water separator. Perform inspection by following the fuel hoses of fuel tank, water separator, fuel pump, engine, parts provided by the engine manufacturer, and fuel tank in this order.
4. If cracks or flaws are observed on the fuel hose, replace it. If a clamp is loose, tighten it.
5. Close the engine cover.
6. Lower the dump body. For details, see "4.1 OPERATING DUMP BODY in OPERATION".

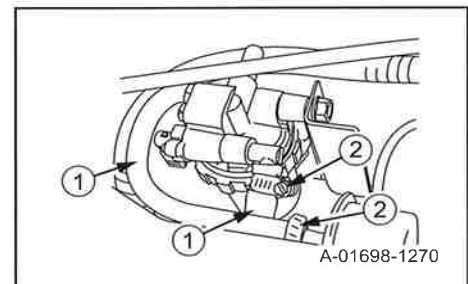

7.8 EVERY 100 HOUR MAINTENANCE

★ Carry out "every 50 hour maintenance" at the same time.

[1] CHECK BATTERY ELECTROLYTE LEVEL AND ADD DISTILLED WATER

WARNING

- If any tool touches between the battery positive (+) terminal and the chassis, sparks may occur. It is dangerous. Do not put tools and other metal objects in your breast pocket. They may fall out.
- Battery electrolyte contains sulphuric acid. If you get acid on yourself, immediately flush the area with large amounts of water. If acid gets into your eyes, flush them immediately with large amounts of fresh water, then see a doctor for treatment.
- Batteries generate hydrogen gas and can explode. Do not smoke, use a lighter, or create any spark near the battery.

1. Open the battery inspection cover.
2. Look into the battery indicator (1) to check.
 - ★ If indicator (1) is "Green", the specific gravity of battery electrolyte and its level are normal.
 - ★ If indicator (1) is "Black", the specific gravity of battery electrolyte is low.
 - ★ If indicator (1) is "White", level of battery electrolyte is low.

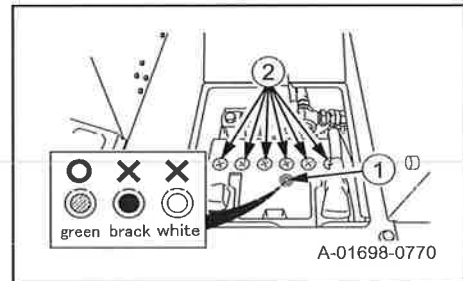

3. If indicator (1) color is "Black", recharge the battery.
If indicator (1) color is "White", open all caps (2) and refill distilled water.
 - ★ If indicator (1) color does not turn "Green" even after adding distilled water, recharge the battery.
 - ★ If the indicator (1) color does not turn "Green" even after the battery is recharged, replace the battery.
4. Close the battery inspection cover.



[2] CHANGE ENGINE LUBRICATING OIL

! WARNING

- Stop the engine and wait for the oil temperature to cool down.
- After adding oil, tighten the cap and drain plug securely and wipe up any spilled oil.

★ Set a container under the engine to catch oil.

1. Go under the machine, remove drain plug (1) on the engine oil pan and drain oil.
 - ★ Set the container under the hydraulic tank to catch oil.
 - ★ Be careful not to get oil on yourself.
2. Inspect the drained oil.
 - ★ If there are large amounts of metal particles or foreign matter in the drained oil, please contact your distributor.
3. After completely draining the oil, tighten drain plug (1).
4. Open the engine cover.
5. Remove filler cap (2) and add the specified amount of engine oil.
 - ★ For details on the engine oil to use, see "3. USE OF FUEL AND LUBRICANTS ACCORDING TO AMBIENT TEMPERATURE in MAINTENANCE".
 - ★ Specified engine oil refill amount: 6.5 liters (1.72 USgal, 1.43UKgal)
 - ★ Use a container with a hose when filling oil.
6. Start the engine and run at idle speed for several minutes, then check the engine lubricating oil level. For details, see "7.6 CHECKS BEFORE STARTING in MAINTENANCE".
 - ★ If engine oil level is low, add oil.
 - Also ensure that no engine oil leak is observed from the drain plug.
7. Close the engine cover.

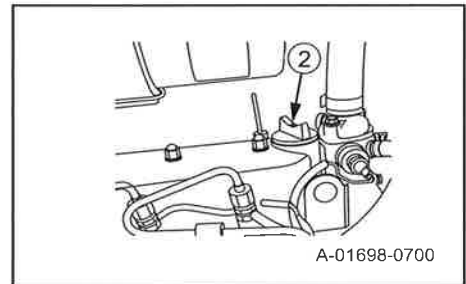
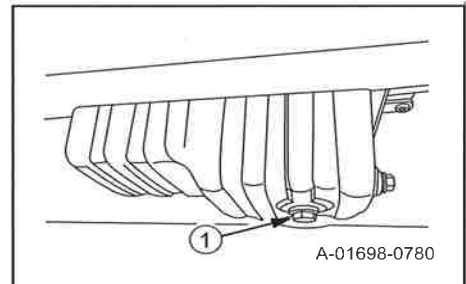

[3] DRAIN WATER AND SEDIMENT FROM WATER SEPARATOR

WARNING

- Stop the engine and wait for the engine to cool down.
- Do not smoke or bring any flame close.

NOTICE

After draining water and sediment from the water separator, bleed air from the fuel circuit.

- ★ Set a container to receive fuel under the water separator.
- ★ Prepare a filter wrench.
- ★ The water separator is located near the fly wheel on the right side of the engine.

1. Open the engine cover.
2. Close valve (1) at upper part of the water separator.
3. Loosen ring (2) by using a filter wrench. Remove cup (3).
4. Drain sediment and water from cup (3).
 - ★ Do not lose spring (5) and float (6) of the cup.
5. Fill fuel in cup (3) and install it on the filter mount. Tighten ring (2).
6. Open valve (1) at upper part of the water separator.
7. Close the engine cover.

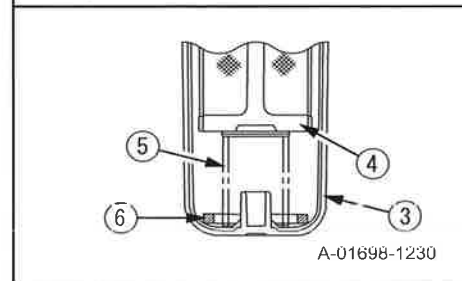
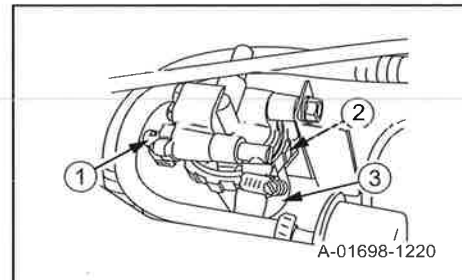

[4] CLEAN AIR CLEANER ELEMENT

1. Clean the air cleaner element. For details, see "7.5 CHECKS WHEN REQUIRED in MAINTENANCE".

[5] CHECK COOLING FAN FOR DAMAGE

1. Open the engine cover.
2. Remove the operator's seat side cover.
3. Check engine cooling fan (1) for chips, cracks and scratches.
 - ★ If any abnormality is found on the cooling fan, please contact your distributor.
4. Install the operator's seat side cover.
5. Close the engine cover.

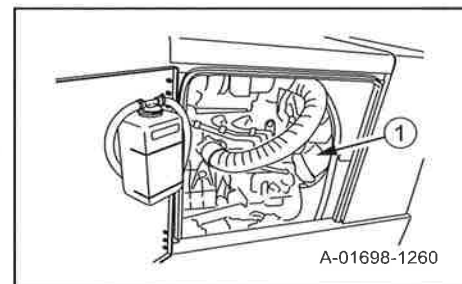



7.9 EVERY 200 HOUR MAINTENANCE

★ Carry out "every 50 hour maintenance" and "every 100 hour maintenance" at the same time.

[1] REPLACE ENGINE OIL FILTER

WARNING

- Stop the engine and wait for the oil temperature to cool down.
- After adding oil, tighten the cap and drain plug securely and wipe up any spilled oil.

★ Set a container under the filter to catch the oil.

★ Prepare a filter wrench.

1. Remove the operator's seat side cover.
2. In order not to let dirt into the system, clean periphery of oil filter cartridge (4) before replacing the cartridge.
3. Turn oil filter cartridge (4) counterclockwise by using a oil filter wrench to remove it.
4. Clean the oil filter mount, coat engine oil on the packing surface of the new oil filter cartridge, and then install it to the mount.
 - ★ Fill engine oil into the new filter cartridge.
 - ★ When installing a new filter cartridge, always tighten it by hand and be careful not to overtighten.
5. Start the engine and run at idle speed for several minutes, then check the engine lubricating oil level by referring "7.6 CHECKS BEFORE STARTING in MAINTENANCE".
6. Install the operator's seat side cover.

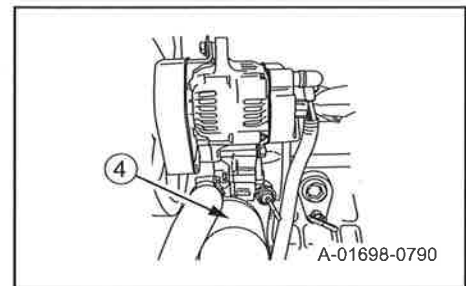

[2] CHECK AIR CLEANER HOSE, CLOSED BREATHER HOSE

! WARNING

- Stop the engine and wait for the engine to cool down.

1. Open the engine cover.
2. Check air cleaner hose (1) and closed breather hose (3) for cracks, flaws or holes. Check clamps (2) (2 places) and cramps (4) (2 places) for looseness.
3. If cracks, flaws or holes are observed on a hose, replace it. If a clamp is loose, tighten it.
4. Close the engine cover.

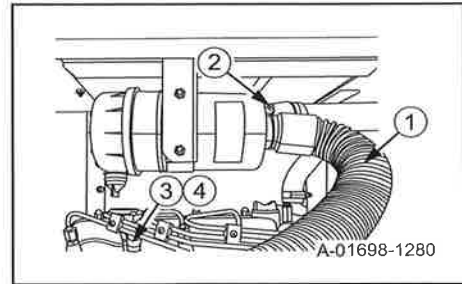

[3] CHECK RADIATOR HOSE, CLAMP

! WARNING

- Stop the engine and wait for the engine to cool down.

1. Open the engine cover.
2. Remove the operator's seat side cover.
3. Check radiator hoses (1), (3) for cracks or flaws. Check clamps (2) (2 places) and cramps (4) (2 places) for looseness.
4. If cracks or flaws are observed on the radiator hose, replace it. If a clamp is loose, tighten it.
5. Install the operator's seat side cover.
6. Close the engine cover.

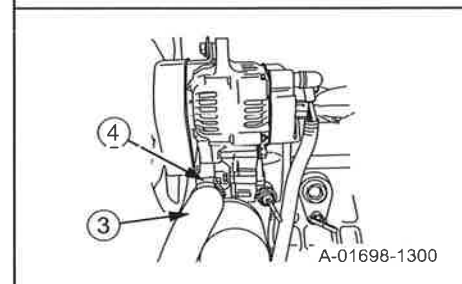
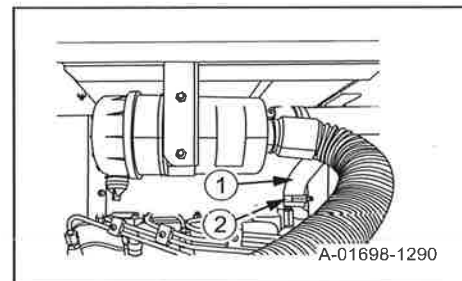



7.10 EVERY 250 HOUR MAINTENANCE

★ Carry out "every 50 hour maintenance" at the same time.

[1] GREASE DUMP BODY REAR SIDE FLAP OPERATING ROD

1. Go under the machine, grease the pins (left and right: 10 locations) at the link part of both ends of the flap operating rods (1).

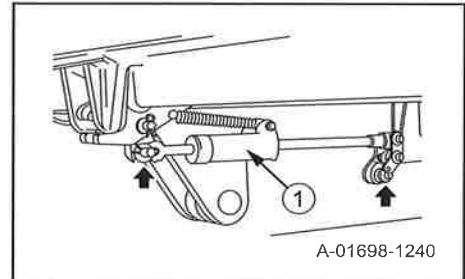

[2] CHECK SWING PINION PART GREASE LEVEL, ADD GREASE IF NECESSARY

! WARNING

- After raising the dump body, be sure to set the safety bar to prevent the dump body from lowering.
- Stop the engine and wait for the oil temperature to cool down.

1. Raise the dump body. For details, see "4.1 OPERATING DUMP BODY in OPERATION".
2. Check whether the grease circulates to swing gear (1) through the inspection port.
If insufficient, refill about "0.1 liters (0.11 USqt, 0.09 UKqt)" of grease.
3. Check the grease for white turbidity.
4. If the grease becomes milky due to mixing of water, dirt, etc., remove old grease and refill with new grease.
5. Lower the dump body. For details, see "4.1 OPERATING DUMP BODY in OPERATION".

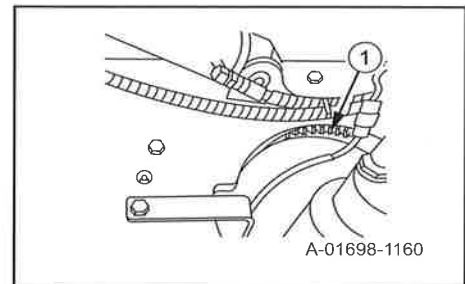

[3] GREASE SWING BEARING

! WARNING

- After raising the dump body, be sure to set the safety bar to prevent the dump body from lowering.
- Stop the engine and wait for the oil temperature to cool down.

★ Prepare a grease pump.

1. Raise the dump body. For details, see "4.1 OPERATING DUMP BODY in OPERATION".
2. Grease through grease points.
 - ★ Continue greasing until old grease is extruded.
 - ★ Be sure to use bearing grease.
3. After greasing, wipe off extruded old grease.
4. Lower the dump body. For details, see "4.1 OPERATING DUMP BODY in OPERATION".

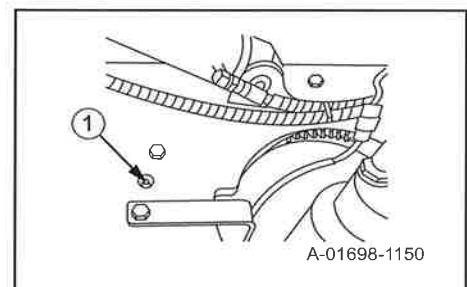

7.11 EVERY 450 HOUR MAINTENANCE

★ Carry out "every 50 hour maintenance" at the same time.

[1] CLEAN WATER SEPARATOR

WARNING

- Stop the engine and wait for the engine to cool down.
- Do not smoke or bring any flame close.

NOTICE

After cleaning the water separator, bleed the air from the fuel circuit.

★ Set a container to receive fuel under the water separator.

★ Prepare a filter wrench.

★ The water separator is located near the fly wheel at the right side of the engine.

1. Open the engine cover.
2. Close valve (1) at upper part of the water separator.
3. Loosen ring (2) by using a filter wrench. Remove cup (3) and strainer (4).
4. Remove spring (5) and float (6) from cup (3).
 - ★ Do not lose spring (5) and float (6) of the cup.
5. Wash cup (3), strainer (4), spring (5), and float (6) with light oil or cleaning oil.
6. Install strainer (4).
 - ★ Replace O-ring with a new one when cleaning the strainer.
7. Fill fuel in cup (3) and install it on the filter mount. Tighten ring (2).
8. Open valve (1) at upper part of the water separator.
9. Close the engine cover.

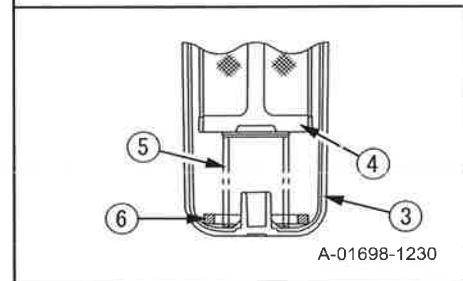
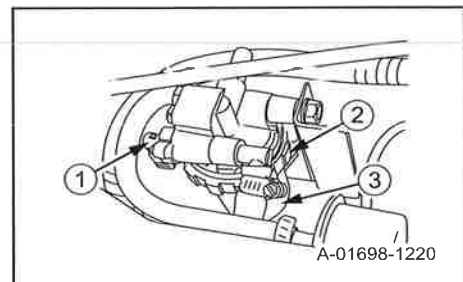

[2] REPLACE FUEL FILTER

! WARNING

- Stop the engine and wait for the engine to cool down.
- Do not smoke or bring any flame close.

NOTICE

After replacing the fuel filter, bleed the air from the fuel circuit.

- ★ Set a container under the fuel filter to catch the fuel.
- ★ Prepare a filter wrench.
- ★ Fuel filter is installed near the fuel injection pump on the right side of the engine.

1. Open the engine cover.
2. Close valve (1) at upper part of the fuel filter.
3. Loosen ring (2) by using a filter wrench. Remove element cup (3) and element (4).
4. Wash element cup (3) with light oil or cleaning oil. Install a new element (4).
5. Fill fuel in element cup (3) and install it on the filter mount. Tighten ring (2).
 - ★ Replace O-ring with a new one when replacing element.
6. Open valve (1) at upper part of the fuel filter.
7. Close the engine cover.

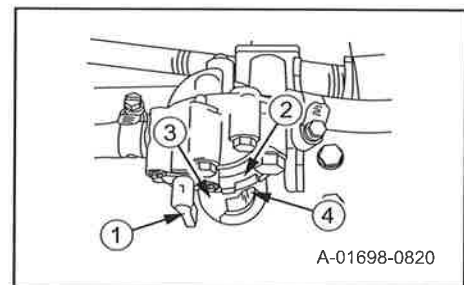

A-01698-0820



7.12 EVERY 500 HOUR MAINTENANCE

★ Carry out "every 50 hour maintenance", "every 100 hour maintenance" and "every 250 hour maintenance" at the same time.

[1] REPLACE HYDRAULIC OIL LINE FILTER

WARNING

- Stop the engine and wait for the oil temperature to cool down.
- Loosen the filler cap on the hydraulic tank slowly to release the internal pressure completely, then remove the filler cap.
- Operate the travel lever and dump control lever a few times to the end of their stroke to completely release the remaining pressure in the hydraulic circuit.
- After raising the dump body, be sure to set the safety bar to prevent the dump body from lowering.
- When installing a new filter cartridge, always tighten it by hand and be careful not to overtighten.

NOTICE

When replacing the hydraulic line filter, always change the oil in the hydraulic tank at the same time.

★ Set a container under the hydraulic line filter to catch oil.

★ Prepare a filter wrench.

1. Raise the dump body. For details, see "4.1 OPERATING DUMP BODY in OPERATION".

2. Set a filter wrench on element part (1) of the line filter and turn the wrench counterclockwise. Remove element (1).

3. Clean filter body (2).

4. Install new element (1) to filter body (2).

★ Fill hydraulic oil into the new filter cartridge.

★ When installing new element (1), always tighten it by hand and be careful not to overtighten.

5. Lower the dump body. For details, see "4.1 OPERATING DUMP BODY in OPERATION".

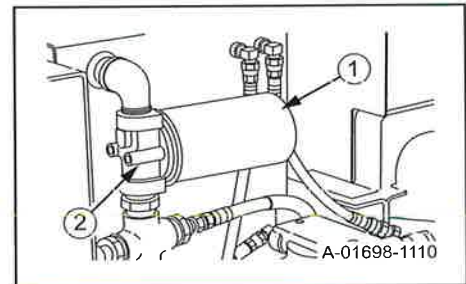



[2] CHANGE OIL IN HYDRAULIC TANK

WARNING

- Stop the engine and wait for the oil temperature to cool down.
- Loosen the filler cap on the hydraulic tank slowly to release the internal pressure completely, then remove the filler cap.
- Operate the travel lever and dump control lever a few times to the end of their stroke to completely release the remaining pressure in the hydraulic circuit.
- After adding oil, tighten the filler cap and drain plug securely, then wipe up any spilled oil.

NOTICE

When changing the oil in the hydraulic tank, always replace the hydraulic oil line filter at the same time.

★ Set a container under the hydraulic tank to catch the oil.

1. Remove oil filler cap (2).

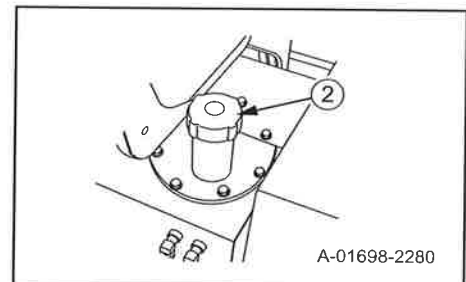

2. Go under the machine, turn drain plug (3) at the bottom of the hydraulic tank counter clockwise, and drain oil from the hydraulic tank.

- ★ Set the container under the hydraulic tank to catch oil.
- ★ Be careful not to get oil on yourself.

3. Inspect the drained oil.

- ★ If there are large amounts of metal particles or foreign matter in the drained oil, please contact your distributor.

4. After completely draining the oil, tighten drain plug (3).

5. Fill specified amount of hydraulic oil through the oil filler.

- ★ For details of hydraulic oil, see "3. USE OF FUEL, COOLANT AND LUBRICANTS ACCORDING TO AMBIENT TEMPERATURE in MAINTENACE".
- ★ Hydraulic oil refill amount: 42 liters (11.1 USgal, 9.2 UKgal)
- ★ Use a container with a hose when filling oil.

6. Check the oil level in the hydraulic tank. For details, see "7.6 CHECKS BEFORE STARTING item [4] in MAINTENANCE".

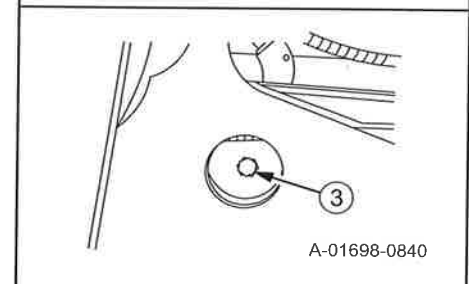

**[3] REPLACE FAN BELT****⚠ WARNING**

- Stop the engine and wait for the oil temperature to cool down.

1. Remove the operator's seat side cover.
2. Loosen and remove the old fan belt. For details, see "7.6 CHECKS BEFORE STARTING item [5] in MAINTENANCE".
3. Install new fan belt and adjust the fan belt tension. For details, see "7.6 CHECKS BEFORE STARTING item [5] in MAINTENANCE".
4. Install the operator's seat side cover.

7.13 EVERY 800 HOUR MAINTENANCE

★ Carry out "every 50 hour maintenance", "every 100 hour maintenance" and "every 200 hour maintenance" at the same time.

[1] ADJUST VALVE CLEARANCE

★ Special skill is required to adjust. Contact your distributor.

[2] MEASURE COMPRESSION PRESSURE

★ Special skill is required to measure. Contact your distributor.

7.14 EVERY 1500 HOUR MAINTENANCE

★ Carry out "every 50 hour maintenance", "every 100 hour maintenance" and "every 500 hour maintenance" at the same time.

[1] CHANGE OIL INSIDE TRAVEL MOTOR REDUCTION GEAR CASE

WARNING

- Stop the engine and wait for the oil temperature to cool down.
- After adding oil, tighten the plugs securely and wipe up any spilled oil.

★ Set a container under the travel motor reduction gear case to catch the oil.

1. Drive the machine forward or backward to position drain plug (1) of the reduction gear case at the bottom, then stop the engine.
2. Remove oil filler plug (2), oil level inspection plug (3), and drain plug (1), then drain oil.
 - ★ Set the container under the hydraulic tank to catch oil.
3. Inspect the drained oil.
 - ★ If there are large amounts of metal particles or foreign matter in the drained oil, please contact your distributor.
4. After completely draining the oil, tighten drain plug (1).
5. Add the specified amount of gear oil through the oil filler, and check that oil comes out from the oil level inspection plug (3) hole.
 - ★ For details of the gear oil, see "3. USE OF FUEL AND LUBRICANTS ACCORDING TO AMBIENT TEMPERATURE in MAINTENANCE".
 - ★ Specified amount of gear oil:
0.6 liters (0.16 USgal, 0.13 UKgal)
6. Tighten oil filler plug (2) and oil level inspection plug (3).

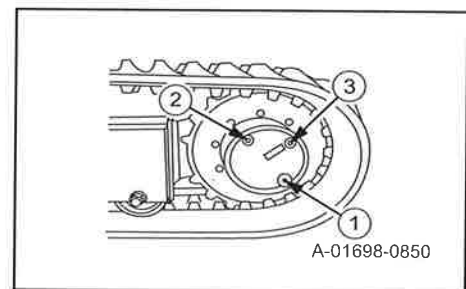

[2] CHECK, CLEAN INJECTION NOZZLE

★ Special tools are required to check. Contact your distributor.

7.15 EVERY 3000 HOUR MAINTENANCE

★ Carry out "every 50 hour maintenance", "every 100 hour maintenance", "every 200 hour maintenance", "every 250 hour maintenance", "every 500 hour maintenance", and "every 1500 hour maintenance" at the same time.

[1] CHECK FUEL INJECTION PUMP

★ Special tools are required to check. Contact your distributor.

[2] CHECK TURBO CHARGER

★ Special tools are required to check. Contact your distributor.





SPECIFICATIONS

1. Dimension drawing	4 - 2
2. Specifications table	4 - 3

1. DIMENSION DRAWING

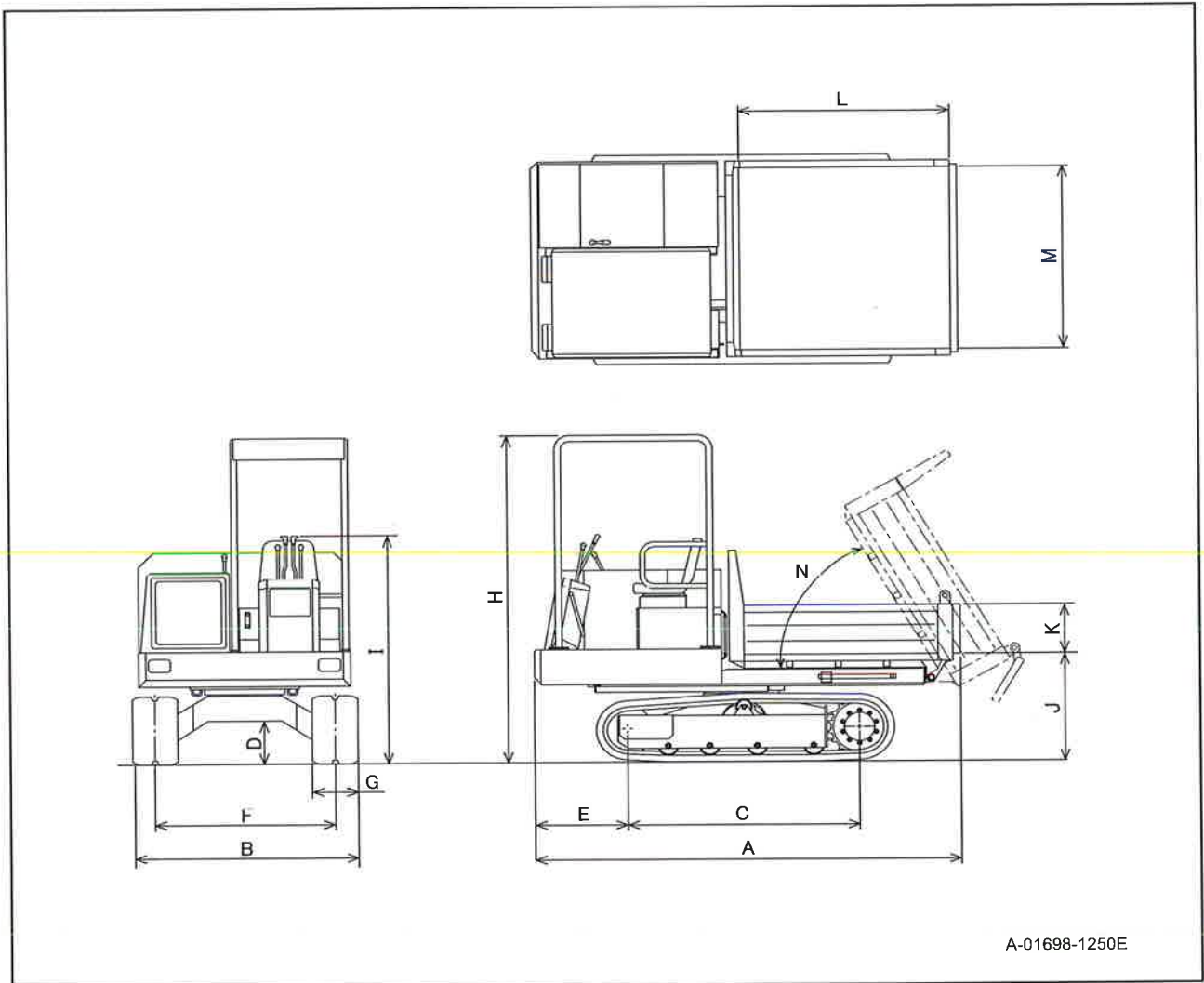



2. SPECIFICATIONS TABLE

Model name			MST-200VDR
A	Overall length	(mm)	2850
B	Overall width	(mm)	1500
C	Distance between center of idler and center of sprocket	(mm)	1545
D	Min. ground clearance	(mm)	345
E	Distance between front of machine and center of idler	(mm)	630
F	Track gauge	(mm)	1200
G	Track width	(mm)	300
H	Overall height (canopy top)	(mm)	2340
I	Overall height (travel levers)	(mm)	1720
J	Clearance between ground and bottom of dump body	(mm)	800
K	Dump body height	(mm)	345
L	Dump body length	(mm)	1400
M	Dump body width	(mm)	1300
N	Max. dumping angle	(deg.)	60
	Front swing radius	(mm)	1550
	Dump body side swing radius	(mm)	1595
	Base machinery mass	(kg)	2000
	Max. payload	(kg)	2000
	Drive system		Fully hydraulic system
	Speed change system		Step-less speed change
	Travel speed (at high speed range)	(km/h)	0 – 5.5
	Travel speed (at low speed range)	(km/h)	0 – 3.0
	Ground contact pressure (unloaded)	(kPa)	21
	Ground contact pressure (loaded)	(kPa)	42
	Hydraulic tank rated capacity	(liter)	40
	Engine model		KUBOTA V1505-E4B-KEA-1
	Engine type		4-cycle, water-cooled, in-line upright, swirl-chamber type
	No. of cylinders - bore x stroke	(mm)	4 - 78 x 78.4
	Piston displacement	(liter)	1.498
	Rated output/engine speed	(kW/min ⁻¹)	18.5/2800
	Maximum engine torque/speed	(N·m/min ⁻¹)	92.6/1700
	Fuel		Diesel oil
	Fuel tank capacity	(liter)	50
	Battery		12V, 45 Ah (5 hour rate) 75D23R



FULL ROTATION TYPE
RUBBER CRAWLER CARRIER
MST-200VDR
OPERATION AND MAINTENANCE MANUAL

Document No.AE10200VDR4-01
First edition: January 10, 2018

Issued by Morooka Co., Ltd.
358 Shoubeisindenmachi, Ryugasaki,
Ibaraki 301-0031,
Japan

No part of this manual can be reproduced in any form without permission



MOROOKA CO., LTD.